

Rubber Fab

Sanitary Hose, Fittings & Adapters

*The Ultimate Source
for Manufacturers,
Fabricators, and
Design Engineers*



Rubber Fab
a Garlock Hygienic Technologies company

About Rubber Fab



Rubber Fab was founded in 1995 by Robert DuPont, Sr. and Patrick Parisi (former owners of Sani-Tech®) located in Andover, NJ. The business has grown through the market and sale of new, innovative products and was relocated to a new state of the art facility in Sparta, NJ in November 2008.

In April 2016, Rubber Fab became part of the Garlock family of companies in an acquisition with parent company EnPro Industries. Headquartered in Palmyra, NY, the Garlock family of companies is acknowledged as the global leader in high-performance fluid sealing and pipeline protection products for industry and infrastructure. Garlock products are at work in many critical and highly regulated industries, including Pharmaceutical, Food & Beverage, Chemical, Oil & Gas, and many others.

Rubber Fab is the leading innovator of high quality sanitary gaskets, hose, hose assemblies, tubing, pump, and filler machine components in a wide range of high purity and metal detectable/x-ray inspectable elastomeric materials. Rubber Fab manufactures, markets, and sells specialized trademarked products: Tuf-Steel®, Tuf-Flex®, Torque-Rite®, Smart Gasket®, Detectomer®, and ADI Free®.

Disclaimer: The information provided within by Rubber Fab is deemed to be accurate; however, it should be used only as a general reference to aid in product selection and application. **Note:** A material's properties may be affected greatly by temperature, operating pressure, concentration, and the presence of other chemicals. Ultimately, the consumer/user must determine the compatibility of any material based on tests done under particular process conditions.

Rubber Fab

a Garlock Hygienic Technologies company

Sanitary Hose Fittings & Adapters

*The Ultimate Source
for Manufacturers,
Fabricators, and
Design Engineers*

FDA Rubber Hose	4
Wash Down Rubber Hose	9
Smoothbore Fluoropolymer Hose	10
Convuluted PTFE Hose	16
Metal Hose	19
Sight Gauges/Level Indicators	22
Metal Detection Tube	27
Silicone Hose	28
FDA PVC Hose	32
Tubing	38
Accessories	42
Fittings & Adapters	57
Dimensional Chart	54
Golden Bridge	44
How To Build a Hose	46
Sanitary Clamps	73
Smart Clamp™	77
Torque Tee	75
Torque-Rite®	76
Tri-Clamp® Sizing Guide	50
Value Added Services	78



Standard Number 62-02

Rubber Fab
Hose Assemblies
are 3A Certified.

FDA Rubber Hose

Rubber Fab FDA approved rubber hoses are designed to transport a wide variety of fluids without imparting odor or taste and are specifically designed for sanitary suction and discharge applications. FDA rubber hoses are recommended for the transfer of milk, juice, soft drinks, yogurt, pharmaceuticals, cosmetics, and oil based or water based products.

RFFDAEOC DIVERSA-FLEX™



Food Grade FDA Smoothbore EPDM Lined Red Smooth/Glossy Outer Convuluted Rubber Cover Hose

TUBE: Smooth white EPDM, phthalate free, REACH compliant

COVER: Wide corrugated FDA rubber with red, low friction, smooth/glossy, UHMW cover

REINFORCEMENT: Synthetic plies, steel wire helixes

TEMPERATURE: -40°F to 245°F

RFFDAE



Food Grade FDA EPDM Rubber Hose

TUBE: Smooth white EPDM

COVER: Grey EPDM rubber

REINFORCEMENT: Two polyester spirals with dual helix wire

TEMPERATURE: -20°F to 300°F

RFFDAELF



Food Grade FDA EPDM Rubber Lay Flat Hose

TUBE: Smooth white EPDM

COVER: Grey EPDM rubber

REINFORCEMENT: Multiple textile plies

TEMPERATURE: -20°F to 300°F

RFF&B



Food Grade FDA Nitrile/PVC Blend Lined Food and Beverage Crush Resistant Hose

TUBE: Smooth white nitrile/PVC blend

COVER: Grey EPDM rubber

REINFORCEMENT: Synthetic high tensile textile with static conductive filament and monofilament helix

TEMPERATURE: -40°F to 230°F

RFFDA



Food Grade FDA Nitrile Rubber Hose

TUBE: Smooth white nitrile

COVER: White nitrile rubber (abrasion and oil resistant)

REINFORCEMENT: Two polyester spirals with dual helix wire

TEMPERATURE: -40°F to 180°F

RFFDAC



Food Grade FDA Chlorobutyl Lined Hose

TUBE: Smooth white chlorobutyl

COVER: Grey EPDM rubber

REINFORCEMENT: Two polyester spirals with dual helix wire

TEMPERATURE: -40°F to 225°F

RFFDABOC



Food Grade FDA Bromobutyl Lined Hose

TUBE: Smooth white bromobutyl, phthalate free

COVER: Corrugated purple, low friction, smooth/glossy, UHMWPE cover, easy to clean, abrasion resistant

REINFORCEMENT: Synthetic plies, steel wire helixes

TEMPERATURE: -40°F to 250°F



DID YOU KNOW?

Rubber Fab fittings and adapters are also available in **304 Stainless Steel.**

RFFDAEOC DIVERSA-FLEX™



Food Grade FDA Smoothbore EPDM Lined Red Smooth/Glossy Outer Convoluted Rubber Cover Hose

TUBE: Smooth white EPDM, phthalate free, REACH compliant

COVER: Wide corrugated FDA rubber with red, low friction, smooth/glossy, UHMW cover

REINFORCEMENT: Synthetic plies, steel wire helices

TEMPERATURE: -40°F to 245°F

Part Number	Hose ID Inch	Hose OD Inch	Bend Radius Inch	Max. Working Pressure @ 70°F psig	Vacuum Rating @ 70°F in. Hg.	Weight Per Foot
16RFFDAEOC	1.00	1.46	2.76	150	FULL	0.58
24RFFDAEOC	1.50	2.00	3.15	150	FULL	0.77
32RFFDAEOC	2.00	2.52	3.94	150	FULL	1.00
40RFFDAEOC	2.50	3.09	5.12	150	FULL	1.36
48RFFDAEOC	3.00	3.62	5.91	150	FULL	1.70
64RFFDAEOC	4.00	4.65	9.80	150	FULL	2.55

Features

- Lightweight
- Flexible
- Low drag resistance
- Cover is abrasion, oil, and chemical resistant
- Smooth glossy cover resists dirt and mold
- Ozone and fade resistance cover guards against premature aging
- Easy to clean
- Phthalate free
- Static grounding available

Applications

- Milk transfer
- Water transfer
- Food and beverage transfer
- Non-fatty and non-oily food products
- Suction and discharge

Hose Certifications

- FDA 21 CFR 177.2600
- 3-A Sanitary Standards
- USDA
- REACH Compliant



RFFDAE



Food Grade FDA EPDM Rubber Hose

TUBE: Smooth white EPDM

COVER: Grey EPDM rubber

REINFORCEMENT: Two polyester spirals with dual helix wire

TEMPERATURE: -20°F to 300°F

Part Number	Hose ID Inch	Hose OD Inch	Bend Radius Inch	Max. Working Pressure @ 70°F psig	Vacuum Rating @ 70°F in. Hg.	Weight Per Foot
08RFFDAE	0.50	0.97	1.50	300	FULL	0.30
12RFFDAE	0.75	1.27	2.50	300	FULL	0.44
16RFFDAE	1.00	1.50	3.00	300	FULL	0.57
24RFFDAE	1.50	2.09	4.50	300	FULL	0.91
32RFFDAE	2.00	2.63	6.00	250	FULL	1.30
40RFFDAE	2.50	3.17	8.00	200	FULL	1.74
48RFFDAE	3.00	3.72	10.00	200	FULL	2.42
64RFFDAE	4.00	4.78	14.00	150	FULL	3.22
96RFFDAE	6.00	6.79	28.00	100	FULL	5.35

Features

- Smooth inner bore
- Will not impart taste or odor
- Full vacuum
- Abrasion resistant
- Chemical and ozone resistant
- Static grounding available

Applications

- Sanitary suction and discharge
- Hot air blower service for food applications
- Food and beverage transfer
- Dairy
- CIP pharmaceutical
- Non-fatty and non-oily food products

Hose Certifications

- FDA 21 CFR 177.2600
- 3-A Sanitary Standards
- USDA
- Conforms to the construction criteria of the Grade A Pasteurized Milk Ordinance



RFFDAELF

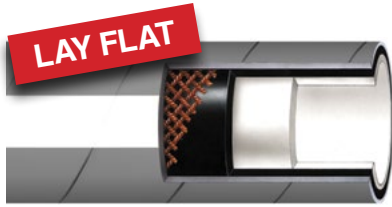

Food Grade FDA EPDM Rubber Lay Flat Hose

TUBE: Smooth white EPDM

COVER: Grey EPDM rubber

REINFORCEMENT: Multiple textile plies

TEMPERATURE: -20°F to 300°F

Part Number	Hose ID Inch	Hose OD Inch	Max. Working Pressure @ 70°F psig	Weight Per Foot
16RFFDAELF	1.00	1.34	150	0.40
24RFFDAELF	1.50	1.88	150	0.55
32RFFDAELF	2.00	2.38	150	0.71
40RFFDAELF	2.50	2.88	150	0.88
48RFFDAELF	3.00	3.38	150	1.05
64RFFDAELF	4.00	4.38	150	1.38
96RFFDAELF	6.00	6.88	100	2.04

Features

- Tubing lays flat for easy storage
- Lightweight
- Available in bulk or fabricated assemblies
- Contact Rubber Fab for available lengths and custom colors

Applications

- Milk transfer
- Water transfer
- Food and beverage
- Cosmetics
- CIP pharmaceutical
- Chemical transfer
- Dairy
- Non-fatty and non-oily food products

Hose Certifications

- FDA 21 CFR 177.2600
- 3-A Sanitary Standards
- USDA
- Conforms to the construction criteria of the Grade A Pasteurized Milk Ordinance



RFF&B



Food Grade FDA Nitrile/PVC Blend Lined Food and Beverage Crush Resistant Hose

TUBE: Smooth white nitrile/PVC blend

COVER: Grey EPDM rubber

REINFORCEMENT: Synthetic high tensile textile with static conductive filament and monofilament helix

TEMPERATURE: -40°F to 230°F

Part Number	Hose ID Inch	Hose OD Inch	Bend Radius Inch	Max. Working Pressure @ 70°F psig	Vacuum Rating @ 70°F in. Hg.	Weight Per Foot
12RFF&B	0.75	1.22	2.00	250	FULL	0.42
16RFF&B	1.00	1.48	3.00	250	FULL	0.52
24RFF&B	1.50	2.07	4.50	250	FULL	0.90
32RFF&B	2.00	2.62	6.00	250	FULL	1.21
40RFF&B*	2.50	3.25	12.00	250	FULL	1.81
48RFF&B	3.00	3.86	18.00	250	FULL	2.46
64RFF&B*	4.00	4.88	36.00	250	FULL	3.24

* Consult Factory

Note: Not Recommended For Use In Carbonated Beverages Or Beer Brewing. For brewery applications, please refer to our FDABOC Hose.

Features

- Crush and kink resistant
- Ultra smooth inner bore
- Full vacuum
- Abrasion resistant
- Chemical and ozone resistant
- Will not impart taste or odor
- Ultra smooth bacteria free tube

Applications

- Food and beverage transfer
- Dairy and milk transfer
- Juice and soft drink transfer
- Suitable for many dry bulk products
- Pharmaceutical
- Water based products

Hose Certifications

- FDA 21 CFR 177.2600
- 3-A Sanitary Standards
- USDA
- Conforms to the construction criteria of the Grade A Pasteurized Milk Ordinance



RFFDA



Food Grade FDA Nitrile Rubber Hose

TUBE: Smooth white nitrile

COVER: White nitrile rubber (abrasion and oil resistant)

REINFORCEMENT: Two polyester spirals with dual helix wire

TEMPERATURE: -40°F to 180°F

Part Number	Hose ID Inch	Hose OD Inch	Bend Radius Inch	Max. Working Pressure @ 70°F psig	Vacuum Rating @ 70°F in. Hg.	Weight Per Foot
08RFFDA	0.50	0.97	1.50	200	FULL	0.35
12RFFDA	0.75	1.27	2.50	200	FULL	0.48
16RFFDA	1.00	1.56	3.00	200	FULL	0.75
24RFFDA	1.50	2.13	6.00	150	FULL	1.03
32RFFDA	2.00	2.63	7.00	150	FULL	1.44
40RFFDA	2.50	3.17	8.00	150	FULL	1.92
48RFFDA	3.00	3.69	9.00	150	FULL	2.43
64RFFDA	4.00	4.81	12.00	150	FULL	3.65

Features

- Ultra smooth inner bore
- Full vacuum
- Abrasion resistant cover
- Chemical and ozone resistant
- Will not impart taste or odor
- Static grounding available

Applications

- Oily food
- Potable water
- Sanitary suction and discharge
- Food and beverage transfer
- Dairy
- CIP pharmaceutical

Hose Certifications

- FDA 21 CFR 177.2600
- 3-A Sanitary Standards
- USDA
- Conforms to the construction criteria of the Grade A Pasteurized Milk Ordinance



RFFDAC



Food Grade FDA Chlorobutyl Lined Hose

TUBE: Smooth white chlorobutyl

COVER: Grey EPDM rubber

REINFORCEMENT: Two polyester spirals with dual helix wire

TEMPERATURE: -40°F to 225°F

Part Number	Hose ID Inch	Hose OD Inch	Bend Radius Inch	Max. Working Pressure @ 70°F psig	Vacuum Rating @ 70°F in. Hg.	Weight Per Foot
16RFFDAC	1.00	1.620	3.00	200	FULL	0.70
24RFFDAC	1.50	2.13	4.50	200	FULL	0.98
32RFFDAC	2.00	2.64	6.00	200	FULL	1.37
40RFFDAC	2.50	3.16	7.50	200	FULL	1.77
48RFFDAC	3.00	3.70	9.00	200	FULL	2.23
64RFFDAC	4.00	4.73	12.00	200	FULL	3.18

Features

- Ultra smooth inner bore
- Full vacuum
- Abrasion resistant
- Chemical and ozone resistant
- Will not impart taste or odor
- Static grounding available

Applications

- Dairy and milk transfer
- Juice and soft drink transfer
- Wine and beer
- Non-fatty or non-oily foods
- Cosmetics
- Pharmaceutical

Hose Certifications

- FDA 21 CFR 177.2600
- 3-A Sanitary Standards
- USDA
- Conforms to the construction criteria of the Grade A Pasteurized Milk Ordinance



RFFDABOC



Food Grade FDA Smoothbore Bromobutyl Lined Purple Smooth/Glossy Outer Convuluted Rubber Cover Hose

TUBE: Smooth white bromobutyl, phthalate free

COVER: Corrugated purple, low friction, smooth/glossy, UHMWPE cover, easy to clean, abrasion resistant

REINFORCEMENT: Synthetic plies, steel wire helixes

TEMPERATURE: -40°F to 250°F

Part Number	Hose ID Inch	Hose OD Inch	Bend Radius Inch	Max. Working Pressure @ 70°F psig	Vacuum Rating @ 70°F in. Hg.	Weight Per Foot
16RFFDABOC	1.00	1.46	2.76	250	FULL	0.56
24RFFDABOC	1.50	2.00	3.15	250	FULL	0.87
32RFFDABOC	2.00	2.52	3.94	250	FULL	1.10
40RFFDABOC	2.50	3.09	5.12	150	FULL	1.52
48RFFDABOC	3.00	3.62	5.91	150	FULL	1.92
64RFFDABOC	4.00	4.65	9.80	150	FULL	2.56

RFFDABOC Hose is bromobutyl lined, giving the hose higher operating temperatures and reduced permeability.

Features

- Extremely flexible
- Low friction cover
- Non marking when dragged on floor
- Highly abrasion resistant
- Will not impart taste or odor
- Resistant to CIP solutions

Applications

- Beer
- Ale
- Wine
- Spirits
- Beverage transfer
- Non-oily liquids

Hose Certifications

- FDA 21 CFR 177.2600
- 3-A Sanitary Standards
- Phthalate Free
- USP Class VI



**NO GREAT STORY EVER STARTED WITH SOMEONE EATING A SALAD.
AND NO GREAT BEER CAN BE BREWED WITHOUT
QUALITY SANITARY SEALS AND HOSES.**

**PILSNER
WEIZEN
INDIA PALE ALE
LAGER
PORTER
LAMBIC
STOUT
WHEAT BEER
BEER**



www.rubberfab.com

Rubber Fab

a Garlock Hygienic Technologies company

Wash Down Rubber Hose

Efficient cleaning and sanitation is often neglected as it requires extra work and the positive effects are not immediately visible, however, failures in plant hygiene can cause high financial losses in the long run. Unsanitary conditions result in unattractive and tasteless product, spoilage of valuable product, and/or foodborne diseases.

RFWDAM – Wash Down Hose with Microban®



Wash Down Rubber Hose with Microban®

TUBE: EPDM rubber

COVER: White EPDM rubber

REINFORCEMENT: Textile reinforced

TEMPERATURE: -40°F to 200°F

Part Number	Hose ID Inch	Hose OD Inch	Max. Working Pressure @ 70°F psig	Weight per Foot
08RFWDAM	0.50	0.84	300	0.26
12RFWDAM	0.75	1.17	300	0.42
16RFWDAM	1.00	1.47	300	0.62

Microban® antimicrobial protection is built into the hose to fight against damaging microbes. Microban technology works continuously, even in between cleanings, and won't wash off or wear away with normal use, keeping the hose cleaner longer.

*Consult factory for spray nozzles

Features

- Antimicrobial protection - if exposed to floor contaminants, will not grow bacteria
- Economical hose for wash down needs
- Handles hot water
- Cover resistant to abrasion
- Spiral construction provides excellent flexibility
- Ease of handling
- Suitable for animal, fish, and vegetable fat environments

Applications

- Food processing plants
- Dairies
- Creameries
- Breweries
- Food
- Beverage

Wash Down Spray Nozzle



RFWD-SN-08FPT

Available Hose Connections

1/2" Male NPT x 1/2" Hose Barb

1/2" Male NPT x 3/4" Hose Barb

1/2" Male NPT x 1" Hose Barb

Rubber Fab's Wash Down Spray Nozzle is extremely robust and has a long service life due to its high-quality brass/stainless steel design. Additionally, it is protected against shock, heat and cold and has a rubber protection against any damage from caustic solutions and acids. The Wash Down Spray Nozzle helps to save considerable water and energy costs, which, along with its chemical-free cleaning capability, contributes to the protection of the environment. The flow can be adjusted from a fine spray to a concentrated jet, making the spray nozzle the right choice for a careful and efficient cleaning for nearly any professional application.

Features

- Cleans carefully and ecologically harmless
- Robust and with a long service life
- Resistant to caustic solutions and acids
- Shock-, heat- and cold-proof
- Adjustable water jet
- Self closing
- Can be locked open with trigger lock tab

Applications

- Food Processing
- Beverage Processing
- Pharmaceutical Application
- Chemical Applications

Specifications

- Working pressure up to 25 bar/363 psi
- Water temperature max. +50°C/+122°F
- Flow rate of water 25 l/minute at 5 bar/72 psi
- Internal thread 1/2" Female NPT

Smoothbore Fluoropolymer Hose

Rubber Fab offers a full line of flexible smoothbore FEP, PFA, and PTFE lined sanitary hoses for Pharmaceutical, Food and Beverage, and Industrial applications. Smoothbore fluoropolymer lined hoses are recommended for sanitary, pharmaceutical processing, distillery flex connections, high purity, and high temperature applications.

RFRTPOC DIVERSA-FLEX™



Smoothbore PTFE Lined Hose with Blue Smooth/Glossy Outer Convuluted Rubber Cover Hose

TUBE: Seamless white PTFE, phthalate free, REACH compliant

COVER: Wide corrugated FDA Rubber with blue, low friction, smooth/glossy, UHMW cover

REINFORCEMENT: Synthetic plies, wire helixes

TEMPERATURE: -40°F to 300°F

RFRT



Smoothbore FEP Lined EPDM Rubber Covered Hose

TUBE: Seamless white FEP

COVER: EPDM rubber (abrasion resistant)

REINFORCEMENT: Multiple braids, helical wire

TEMPERATURE: -40°F to 300°F

RFRTTP



Smoothbore Heavy Wall PTFE Lined EPDM Rubber Hose

TUBE: Seamless white HEAVY WALL PTFE

COVER: EPDM rubber (abrasion resistant)

REINFORCEMENT: Multiple braids, helical wire

TEMPERATURE: -20°F to 300°F

RFST



Smoothbore PTFE Lined Hose with Stainless Steel Braided Cover

TUBE: Seamless white PTFE

COVER: Braided stainless steel

TEMPERATURE: -20°F to 350°F

RFSTS

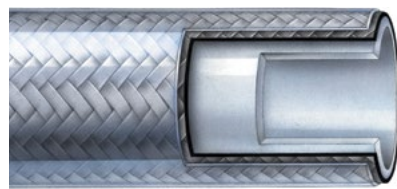

Smoothbore PTFE Lined Hose with Stainless Steel Braid and Clear Silicone Outer Cover

TUBE: Seamless white PTFE

COVER: Braided stainless steel and clear silicone outer cover

TEMPERATURE: -20°F to 350°F

RFSTB



Smoothbore Black Conductive PTFE Lined Hose with Braided Stainless Steel Cover

TUBE: Black conductive PTFE

COVER: Braided stainless steel

TEMPERATURE: -20°F to 350°F

Also available with silicone outer cover
RFSTBS

RFSF SUPREME-FLEX

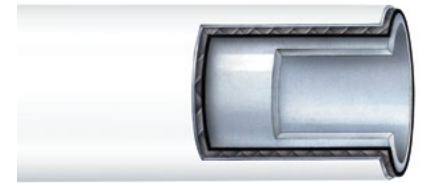

Smoothbore PTFE Lined Hose with Silicone Outer Cover

TUBE: Seamless white PTFE

COVER: White silicone

REINFORCEMENT: 304 stainless steel braid

TEMPERATURE: -100°F to 450°F

RFTFP TUF-FLEX®



Smoothbore PTFE Lined Hose with Synthetic Plies and Stainless Steel Wire Helix

TUBE: Seamless white PTFE

COVER: White silicone

REINFORCEMENT: Synthetic plies and stainless steel wire helix

TEMPERATURE: -40°F to 300°F



DID YOU KNOW?

Rubber Fab fittings and adapters are also available in
304 Stainless Steel.

RFRTPOC DIVERSA-FLEX™



Smoothbore PTFE Lined Hose with Blue Smooth/Glossy Outer Convuluted Rubber Cover Hose

TUBE: Seamless white PTFE, phthalate free, REACH compliant

COVER: Wide corrugated FDA rubber with blue, low friction, smooth/glossy, UHMW cover

REINFORCEMENT: Synthetic plies, wire helixes

TEMPERATURE: -40°F to 300°F

Part Number	Hose ID Inch	Hose OD Inch	Bend Radius Inch	Max. Working Pressure @ 70°F psig	Vacuum Rating @ 70°F in. Hg.	Weight Per Foot
16RFRTPOC	1.00	1.45	5.12	235	FULL	0.52
24RFRTPOC	1.50	2.00	7.48	235	FULL	0.79
32RFRTPOC	2.00	2.60	9.84	235	FULL	1.28
40RFRTPOC	2.50	3.13	12.60	235	FULL	1.62
48RFRTPOC	3.00	3.58	14.96	235	FULL	1.89

Features

- Phthalate free
- Lightweight
- Flexible
- Low drag resistance
- Cover is abrasion, oil, and chemical resistant
- Smooth glossy cover resists dirt and mold
- Ozone and fade resistance cover guards against premature aging
- Easy to clean
- Resistant to mechanical stress
- Static grounding available

Applications

- Chemical and solvent suction and discharge
- Pharmaceutical processing
- Cosmetics
- Food and beverage transfer
- Load cells
- Hot CIP solutions

Hose Certifications

- USP Class VI
- FDA 21 CFR 177.2600
- 3-A Sanitary Standards
- REACH Compliant



RFRT



Smoothbore FEP Lined EPDM Rubber Covered Hose

TUBE: Seamless white FEP

COVER: EPDM rubber (abrasion resistant)

REINFORCEMENT: Multiple braids, helical wire

TEMPERATURE: -40°F to 300°F

Part Number	Hose ID Inch	Hose OD Inch	Bend Radius Inch	Max. Working Pressure @ 70°F psig	Vacuum Rating @ 70°F in. Hg.	Weight Per Foot
08RFRT	0.50	0.97	2.50	500	FULL	0.35
12RFRT	0.75	1.27	2.50	500	FULL	0.52
16RFRT	1.00	1.48	3.00	400	FULL	0.55
24RFRT	1.50	2.04	4.50	350	FULL	0.87
32RFRT	2.00	2.54	7.00	300	FULL	1.17
40RFRT	2.50	3.04	9.00	200	FULL	1.55
48RFRT	3.00	3.81	35.00	200	FULL	2.98
64RFRT	4.00	4.89	20.00	150	FULL	3.98

Features

- EPDM rubber outer cover has multiple textile plies along the entire length
- Double steel wire helix for improved bend radius and shape retention
- Liner is smooth FEP, bonded for full vacuum service
- Non-stick contact surface will not contaminate product
- Inert and resistant to most chemicals and reagents
- Cleanable by CIP, COP methods
- Ultra smooth bacteria free tube
- Static grounding available

Applications

- Pharmaceutical processing
- Water, acid, and chemical transfer
- Hot CIP solutions
- Distillery piping systems
- Electronic industries
- Fluid transfer
- Food and beverage processing
- Load cells
- Cosmetics

Hose Certifications

- Meets USP Class VI Standards
- FDA 21 CFR 177.1550
- FDA 21 CFR 177.2600
- 3-A Sanitary Standards



RF RTP



Smoothbore Heavy Wall PTFE Lined EPDM Rubber Hose

TUBE: Seamless white HEAVY WALL PTFE

COVER: EPDM rubber (abrasion resistant)

REINFORCEMENT: Multiple braids, helical wire

TEMPERATURE: -20°F to 300°F

Part Number	Hose ID Inch	Hose OD Inch	Bend Radius Inch	Max. Working Pressure @ 70°F psig	Vacuum Rating @ 70°F in. Hg.	Weight Per Foot
08RF RTP	0.53	1.00	1.80	600	FULL	0.46
12RF RTP	0.78	1.30	2.50	550	FULL	0.56
16RF RTP	1.03	1.54	3.40	530	FULL	0.79
24RF RTP	1.52	2.19	5.50	430	FULL	1.22
32RF RTP	2.02	2.73	8.00	430	FULL	1.84

Features

- Heavy wall PTFE liner provides good permeation resistance
- Resistant to ozone, chemical, and abrasion
- Double steel wire helix for improved bend radius and shape retention
- Outstanding flexibility
- Non-stick contact surface will not contaminate product
- Inert and resistant to most chemicals and reagents
- Cleanable by CIP, SIP, and COP methods
- Ultra smooth bacteria free tube
- Static grounding available

Applications

- Pharmaceutical processing
- Chemical transfer
- Hot CIP solutions
- Distillery piping systems
- Fluid transfer
- Food and beverage processing
- Load cells
- Cosmetics

Hose Certifications

- USP Class VI
- FDA 21 CFR 177.1550
- FDA 21 CFR 177.2600
- 3-A Sanitary Standards



RF ST



Smoothbore PTFE Lined Hose with Stainless Steel Braided Cover

TUBE: Seamless white PTFE

COVER: Braided stainless steel

TEMPERATURE: -20°F to 350°F

Part Number	Hose ID Inch	Hose OD Inch	Bend Radius Inch	Max. Working Pressure @ 70°F psig	Vacuum Rating @ 70°F in. Hg.	Weight Per Foot
04RF ST	0.25	0.37	3.00	3000	FULL	0.08
06RF ST	0.38	0.51	5.00	2000	FULL	0.11
08RF ST	0.50	0.63	6.50	1425	FULL	0.16
12RF ST	0.75	0.88	8.20	1000	FULL	0.20
16RF ST	1.00	1.19	12.00	1000	FULL	0.50
24RF ST	1.50	1.76	20.00	1000	FULL	0.92

Features

- Outer cover is stainless steel braid overwrap
- Smoothbore PTFE inner core
- Non-stick contact surface will not contaminate product
- Withstands high velocity and pressure surges
- Resists moisture
- Autoclavable

Applications

- Food and beverage processing
- Pharmaceutical processing
- Cosmetics
- Hot CIP solutions
- Chemical products
- Low pressure steam

Hose Certifications

- USP Class VI
- FDA 21 CFR 177.1550
- USDA

RFST – FLARE THRU

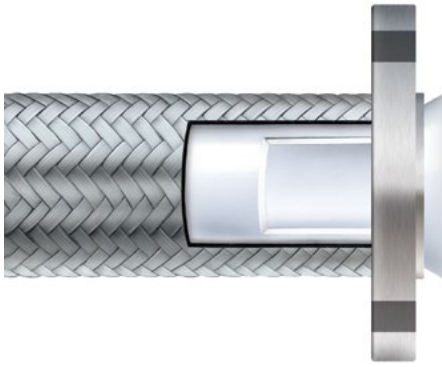

Part Number	Hose ID Inch	Hose OD Inch	Bend Radius Inch	Max. Working Pressure @ 70°F psig	Vacuum Rating @ 70°F in. Hg.	Weight Per Foot
12RFSTFT*	0.75	0.88	8.20	275	FULL	0.20
16RFSTFT	1.00	1.19	12.00	275	FULL	0.50

*Available in 150# flange style only.

Smoothbore Flared PTFE Lined Hose with Stainless Steel Braided Cover

TUBE: Seamless white PTFE
COVER: Braided stainless steel

TEMPERATURE: -20°F to 350°F
FITTINGS: Flare thru 150# flange

Features

- Outer cover is stainless steel braid overwrap
- Smoothbore PTFE inner core
- No bacteria traps with flare thru assembly
- Non-stick contact surface will not contaminate product
- Withstands high velocity and pressure surges
- Resists moisture
- Autoclavable

Applications

- Food and beverage processing
- Pharmaceutical processing
- Cosmetics
- Hot CIP solutions
- Chemical products
- Low pressure steam

Hose Certifications

- USP Class VI
- FDA 21 CFR 177.1550
- 3-A Sanitary Standards
- USDA



RFSTS

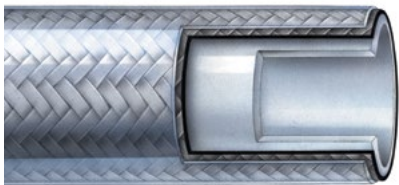

Smoothbore PTFE Lined Hose with Stainless Steel Braid and Clear Silicone Outer Cover

TUBE: Seamless white PTFE

COVER: Braided stainless steel and clear silicone outer cover

TEMPERATURE: -20°F to 350°F

Part Number	Hose ID Inch	Hose OD Inch	Bend Radius Inch	Max. Working Pressure @ 70°F psig	Vacuum Rating @ 70°F in. Hg.	Weight Per Foot
04RFSTS	0.25	0.56	3.00	3000	FULL	0.12
06RFSTS	0.38	0.70	4.00	2000	FULL	0.13
08RFSTS	0.50	0.82	4.00	1425	FULL	0.16
12RFSTS	0.75	1.08	7.00	1000	FULL	0.20
16RFSTS	1.00	1.32	12.00	1000	FULL	0.50
24RFSTS	1.50	1.82	20.00	1000	FULL	0.92

Maximum length 20 feet.

Features

- Outer cover is stainless steel braid overwrap with clear silicone cover
- Silicone cover acts as thermal insulator
- Lining is smooth PTFE inner core, non-stick surface
- Non-stick contact surface will not contaminate contacted substances
- Not affected by weather and will not age in service within the recommended temperature and pressure ratings
- Withstands high velocity and pressure surges
- Conductive black liner available
- Ease of cleanability
- Autoclavable
- Can be steam cleaned

Applications

- Food processing
- Pharmaceutical processing
- Cosmetics
- Hot CIP solutions
- Chemical products
- Low pressure steam

Hose Certifications

- USP Class VI
- FDA 21 CFR 177.1550
- 3-A Sanitary Standards
- USDA



RFSTB



Smoothbore Black Conductive PTFE Lined Hose with Braided Stainless Steel Cover

TUBE: Black conductive PTFE

COVER: Braided stainless steel

TEMPERATURE: -20°F to 350°F

Part Number	Hose ID Inch	Hose OD Inch	Bend Radius Inch	Max. Working Pressure @ 70°F psig	Vacuum Rating @ 70°F in. Hg.	Weight Per Foot
04RFSTB	0.25	0.37	3.00	3000	FULL	0.08
06RFSTB	0.38	0.51	5.00	2000	FULL	0.11
08RFSTB	0.50	0.63	6.50	1425	FULL	0.16
12RFSTB	0.75	0.88	8.20	1000	FULL	0.20
16RFSTB	1.00	1.19	12.00	1000	FULL	0.50

Features

- Conductive liner dissipates static electricity
- Outer cover is stainless steel braid overwrap
- Smoothbore PTFE inner core
- Non-stick contact surface will not contaminate product
- Withstands high velocity and pressure surges
- Resists moisture
- Autoclavable

Applications

- Food processing
- Pharmaceutical processing
- Cosmetics
- Hot CIP solutions
- Chemical products
- Low pressure steam

Hose Certifications

- FDA 21 CFR 177.1550
- USDA
- USP Class VI

RFSTBS



Smoothbore Black Conductive PTFE Lined Hose with Braided Stainless Steel Cover and Clear Silicone Outer Cover

TUBE: Black conductive PTFE

COVER: Braided stainless steel and clear silicone outer cover

TEMPERATURE: -20°F to 350°F

Part Number	Hose ID Inch	Hose OD Inch	Bend Radius Inch	Max. Working Pressure @ 70°F psig	Vacuum Rating @ 70°F in. Hg.	Weight Per Foot
04RFSTBS	0.25	0.56	3.00	3000	FULL	0.12
06RFSTBS	0.38	0.70	4.00	2000	FULL	0.13
08RFSTBS	0.50	0.82	4.00	1425	FULL	0.16
12RFSTBS	0.75	1.08	7.00	1000	FULL	0.20
16RFSTBS	1.00	1.32	12.00	1000	FULL	0.50

Features

- Conductive liner dissipates static electricity
- Silicone cover acts as thermal insulator
- Lining is smooth PTFE inner core, non-stick surface
- Non-stick contact surface will not contaminate contacted substances
- Not affected by weather and will not age in service within the recommended temperature and pressure ratings
- Withstands high velocity and pressure surges
- Ease of cleanability
- Autoclavable
- Can be steam cleaned

Applications

- Food processing
- Pharmaceutical processing
- Cosmetics
- Hot CIP solutions
- Chemical products
- Low pressure steam

Hose Certifications

- FDA 21 CFR 177.1550
- USDA

RFSF SUPREME-FLEX

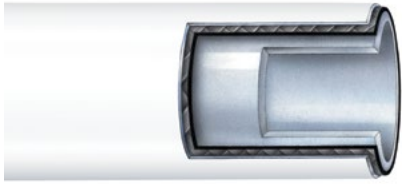

Smoothbore PTFE Lined Hose with Silicone Outer Cover

TUBE: Seamless white PTFE

COVER: White silicone

REINFORCEMENT: 304 stainless steel braid

TEMPERATURE: -100°F to 450°F

Part Number	Hose ID Inch	Hose OD Inch	Bend Radius Inch	Max. Working Pressure @ 70°F psig	Vacuum Rating @ 70°F in. Hg.	Weight Per Foot
04RFSF	0.25	0.50	1.50	3250	FULL	0.13
06RFSF	0.37	0.65	2.00	2500	FULL	0.15
08RFSF	0.50	0.81	3.00	2000	FULL	0.18
12RFSF*	0.75	1.02	8.20	1000	FULL	0.34

*Consult factory for availability

Features

- Superior flexibility
- High pressure rating
- Lining is smoothbore PTFE
- Excellent chemical resistance
- Non-stick contact surface will not contaminate contacted surfaces
- Autoclavable
- Steam cleanable at stated temperature and pressure rating
- Full vacuum rating
- Will not impart taste or odor
- Ultra smooth bacteria free tube

Applications

- Load cell
- CIP/SIP cleaning
- Filling equipment
- Sampling systems
- Fermentation lines
- Food and beverage processing
- Pharmaceutical processing
- Chemical transfer
- Sanitary transfer

Hose Certifications

- USP Class VI
- FDA 21 CFR 177.1550
- 3-A Sanitary Standards
- USDA



RFTFP TUF-FLEX®



Smoothbore PTFE Lined Hose with Synthetic Plies and Stainless Steel Wire Helix

TUBE: Seamless white PTFE

COVER: White silicone

REINFORCEMENT: Synthetic plies and stainless steel wire helix

TEMPERATURE: -40°F to 300°F

Part Number	Hose ID Inch	Hose OD Inch	Bend Radius Inch	Max. Working Pressure @ 70°F psig	Vacuum Rating @ 70°F in. Hg.	Weight Per Foot
08RFTFP	0.50	0.94	1.77	150	FULL	0.31
12RFTFP	0.75	1.18	2.76	150	FULL	0.41
16RFTFP	1.00	1.42	3.54	150	FULL	0.51
24RFTFP	1.50	1.97	5.51	105	FULL	0.84
32RFTFP	2.00	2.44	7.09	105	FULL	1.07

Rubber Fab recommends a Rubber Fab factory crimp for this product. Max length 32.5'

Features

- Extreme flexibility
- Superior cleanability
- Excellent thermal properties
- Ultra smooth bacteria free tube
- Static grounding available
- Resistant to repetitive dynamic cycling
- Autoclavable
- Phthalate free

Applications

- Load cell
- CIP/SIP cleaning
- Filling equipment
- Sampling systems
- Dosing and filling machines
- Fermentation lines
- Food and beverage processing
- Pharmaceutical processing
- Chemical transfer

Hose Certifications

- USP Class VI
- FDA 21 CFR 177.1550
- 3-A Sanitary Standards



Convoluted PTFE Hose

Rubber Fab convoluted PTFE hoses are manufactured with smooth, rounded, helical shaped convolutions which help to promote easy cleaning and self-draining for the ultimate high purity, convoluted hose. Rubber Fab convoluted hose's light weight, flexible characteristics provide a superior flex life. Also available in 150# flange, providing a 100% PTFE coverage on all wetted surfaces.

RFCTLP

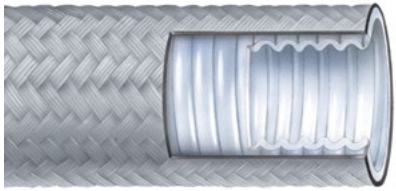

Convoluted Low Profile PTFE Lined Hose with Braided Stainless Steel Cover

TUBE: Seamless white convoluted PTFE

COVER: Braided stainless steel

TEMPERATURE: -20°F to 350°F

RFCTLP FLARE THRU

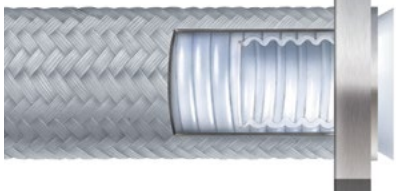

Convoluted Low Profile PTFE Lined Hose with Braided Stainless Steel Cover with Flare Thru Assembly

TUBE: Seamless white convoluted PTFE

COVER: Braided stainless steel

TEMPERATURE: -20°F to 350°F

RFCTLPS



Convoluted Low Profile PTFE Lined Hose with Braided Stainless Steel Cover and Silicone Outer Cover

TUBE: Seamless white convoluted PTFE

COVER: Braided stainless steel

TEMPERATURE: -20°F to 350°F

RFCTLPB

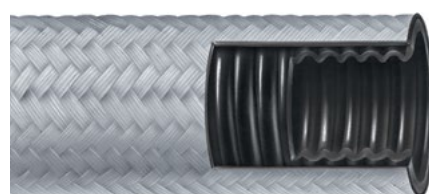

Convoluted Low Profile Black Conductive PTFE Hose with Braided Stainless Steel Cover

TUBE: Seamless black conductive convoluted PTFE

COVER: Braided stainless steel

TEMPERATURE: -20°F to 350°F

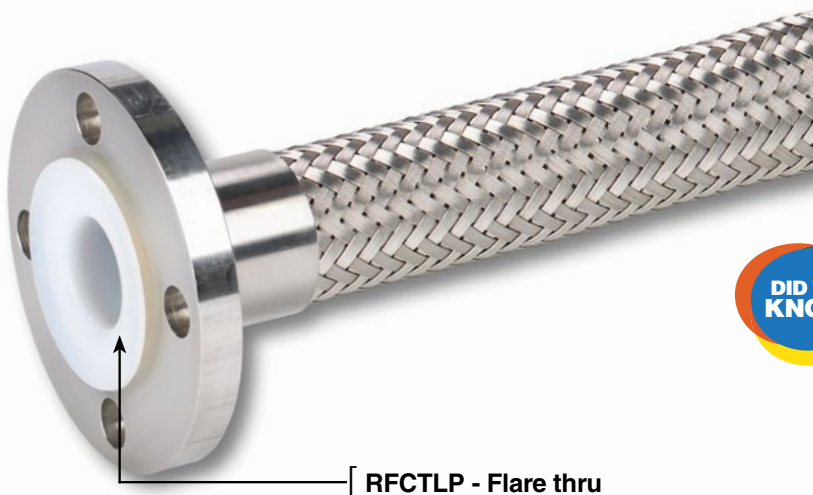

[RFCTLP - Flare thru

HOW TO BUILD A Hose Assembly

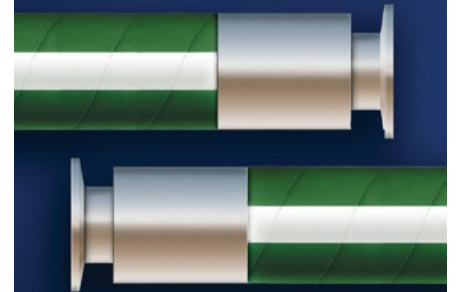

SEE PAGE 46

Sanitary Gaskets



**DID YOU
KNOW?**

Rubber Fab offers a full line of sanitary and specialty gaskets, o-rings, screens, and orifice plates.

CONSULT FACTORY FOR DETAILS.

RFCTLP

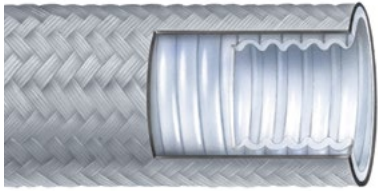

Convoluted Low Profile PTFE Lined Hose with Braided Stainless Steel Cover

TUBE: Seamless white convoluted PTFE

COVER: Braided stainless steel

TEMPERATURE: -20°F to 350°F

Part Number	Hose ID Inch	Hose OD Inch	Bend Radius Inch	Max. Working Pressure @ 70°F psig	Vacuum Rating @ 70°F in. Hg.	Weight Per Foot
08RFCTLP	0.47	0.75	2.00	1425	FULL	0.20
12RFCTLP	0.72	1.05	2.80	1300	FULL	0.30
16RFCTLP	0.97	1.35	4.00	1100	FULL	0.48
24RFCTLP	1.54	2.03	6.00	700	FULL	0.82
32RFCTLP	1.97	2.46	7.50	525	FULL	1.12
48RFCTLP	2.91	3.70	14.00	175	FULL	1.26
64RFCTLP	3.94	5.00	16.00	150	FULL	2.64

Features

- Lower convolutions for minimal pressure drop and ease of cleaning
- Outer cover is stainless steel braid overwrap
- Not affected by weather and will not age in service within the recommended temperature and pressure ratings
- Withstands high velocity and pressure surges
- Unaffected by continuous flexing or vibration when used in accordance with minimum bend radius specifications
- Autoclavable
- Steam cleanable
- Available in bulk or fabricated assemblies
- Phthalate free

Applications

- Food processing
- Pharmaceutical processing
- Cosmetics
- Hot CIP solutions
- Chemical products
- Low pressure steam

Hose Certifications

- USP Class VI
- FDA 21 CFR 177.1550
- USDA
- Meets REACH Standards

RFCTLP – FLARE THRU



Convoluted Low Profile PTFE Lined Hose with Braided Stainless Steel Cover with Flare Thru Assembly

TUBE: Seamless white convoluted PTFE

COVER: Braided stainless steel

TEMPERATURE: -20°F to 350°F

FITTINGS: Flare thru 150# flange

Part Number	Hose ID Inch	Hose OD Inch	Bend Radius Inch	Max. Working Pressure @ 70°F psig	Vacuum Rating @ 70°F in. Hg.	Weight Per Foot
08RFCTLP	0.47	0.75	2.00	500	FULL	0.20
12RFCTLP	0.72	1.05	2.80	500	FULL	0.30
16RFCTLP	0.97	1.35	4.00	500	FULL	0.48
24RFCTLP**	1.54	2.03	6.00	350	FULL	0.82
32RFCTLP**	1.97	2.46	7.50	250	22	1.14
48RFCTLP	2.91	3.70	14.00	175	20	1.26
64RFCTLP*	3.94	5.00	16.00	150	15	2.64

* Available in 150# flange style only.

Features

- Lower convolutions for minimal pressure drop and ease of cleaning
- Outer cover is stainless steel braid overwrap
- Not affected by weather and will not age in service within the recommended temperature and pressure ratings
- Withstands high velocity and pressure surges
- Unaffected by continuous flexing or vibration when used in accordance with minimum bend radius specifications
- Autoclavable
- Steam cleanable
- Phthalate free

Applications

- Food processing
- Pharmaceutical processing
- Cosmetics
- Hot CIP solutions
- Chemical products
- Low pressure steam

Hose Certifications

- USP Class VI
- FDA 21 CFR 177.1550
- USDA
- Meets REACH Standards

RFCTLPS

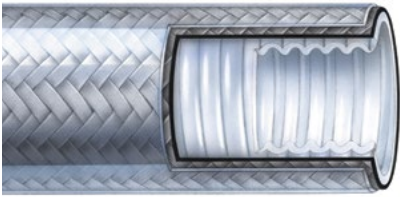

Convoluted Low Profile PTFE Lined Hose with Braided Stainless Steel Cover and Silicone Outer Cover

TUBE: Seamless white convoluted PTFE

COVER: Braided stainless steel

TEMPERATURE: -20°F to 350°F

Part Number	Hose ID Inch	Hose OD Inch	Bend Radius Inch	Max. Working Pressure @ 70°F psig	Vacuum Rating @ 70°F in. Hg.	Weight Per Foot
08RFCTLPS	0.47	0.94	2.00	1425	FULL	0.20
12RFCTLPS	0.72	1.24	2.80	1300	FULL	0.30
16RFCTLPS	0.97	1.54	4.00	1100	FULL	0.48
24RFCTLPS	1.54	2.22	6.00	700	FULL	0.82
32RFCTLPS	1.97	2.65	7.50	525	FULL	1.12
48RFCTLPS	CF	CF	CF	CF	CF	CF
64RFCTLPS	CF	CF	CF	CF	CF	CF

Maximum length 20 feet.

Features

- Lower convolutions for minimal pressure drop and ease of cleaning
- Outer cover is stainless steel braid overwrap with clear silicone cover
- Silicone cover acts as thermal insulator
- Not affected by weather and will not age in service within the recommended temperature and pressure ratings
- Withstands high velocity and pressure surges
- Unaffected by continuous flexing or vibration when used in accordance with minimum bend radius specifications
- Autoclavable
- Steam cleanable
- Available in bulk or fabricated assemblies
- Available with carbon conductive liner
- Phthalate free

Applications

- Food processing
- Pharmaceutical processing
- Cosmetics
- Hot CIP solutions
- Chemical products
- Low pressure steam

Hose Certifications

- USP Class VI
- FDA 21 CFR 177.1550
- USDA
- Meets REACH Standards

RFCTLPB

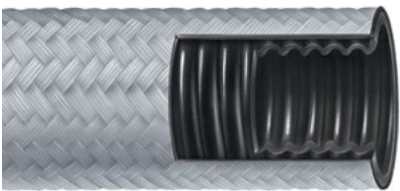

Convoluted Low Profile Black Conductive PTFE Hose with Braided Stainless Steel Cover

TUBE: Seamless black conductive convoluted PTFE

COVER: Braided stainless steel

TEMPERATURE: -20°F to 350°F

Part Number	Hose ID Inch	Hose OD Inch	Bend Radius Inch	Max. Working Pressure @ 70°F psig	Vacuum Rating @ 70°F in. Hg.	Weight Per Foot
08RFCTLPB	0.47	0.75	2.00	1425	FULL	0.20
12RFCTLPB	0.72	1.05	2.80	1300	FULL	0.30
16RFCTLPB	0.97	1.35	4.00	1100	FULL	0.48
24RFCTLPB	1.54	2.03	6.00	700	FULL	0.82
32RFCTLPB	1.97	2.46	7.50	525	FULL	1.12
48RFCTLPB	2.91	3.70	14.00	175	FULL	1.26
64RFCTLPB	3.94	5.00	16.00	150	FULL	2.64

Features

- Lower convolutions allows for smooth product flow and ease of cleaning
- Outer cover is 316 stainless steel braid
- PTFE inner core provides outstanding corrosion resistance and material compatibility
- Unaffected by continuous flexing or vibration when used in accordance with minimum bend radius specifications
- Autoclavable
- Tighter bend radius compared to smoothbore hose styles
- Available in bulk or fabricated assemblies
- Phthalate free

Applications

- Food and beverage processing
- Pharmaceutical processing
- Corn processing
- Flavors
- Chemical processing
- Low pressure steam

Hose Certifications

- FDA 21 CFR 177.1550
- USDA
- USP Class VI

Metal Hose and PTFE Lined Metal Hose

Rubber Fab corrugated metal hoses are flexible, corrosion resistant, high strength, and temperature resistant. They are used for cryogenics, pump connectors, vibration eliminators, pharmaceutical applications, steam, and flexible chemical transfer. Rubber Fab's PTFE lined flare thru hose is specifically designed for applications where dual containment is necessary, where a smooth continuous tube with no transition is required, and where elevated temperatures and working pressures are higher than a traditional PTFE hose withstands.

RFSSH

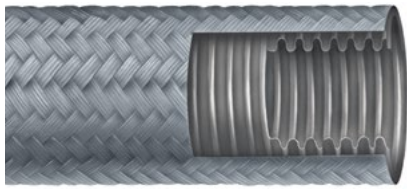

Stainless Steel Corrugated Hose

TUBE: 316L corrugated stainless steel
321 corrugated stainless steel

COVER: 304SS braided stainless steel

TEMPERATURE:

316L SS Core -400°F to 800°F
321 SS Core -400°F to 1500°F

TEMPERATURE CORRECTION CHART

For RFSSH metal hose, as the operating temperature of the hose assembly increases, the maximum working pressure of the assembly decreases.

1. Determine the maximum working temperature of the application.
2. Locate this temperature on the chart and read across to metal alloy selected to find the proper factor.
3. Multiply this factor by the maximum working pressure in the metal hose specification table.
4. This number is your maximum safe working pressure at that elevated temperature.

TEMPERATURE CORRECTION FACTORS

Temp (°F)	304, 316L Stainless	321 Stainless
Room	1.00	1.00
150	0.96	0.97
200	0.92	0.94
250	0.91	0.92
300	0.86	0.88
350	0.85	0.86
400	0.82	0.83
450	0.80	0.81
500	0.77	0.78
600	0.73	0.74
700	0.69	0.70
800	0.64	0.66
900	-	0.62
1000	-	0.60
1100	-	0.58
1200	-	0.55
1300	-	0.50
1400	-	0.44
1500	-	0.40

FLEXIBLE:

RFSSH's assemblies exhibit amazing durability in applications of extreme flexure. Our larger diameter hose boasts a perfectly shaped omega profile to evenly distribute stress.

CLEAN:

RFSSH's inner core is exceptionally clean.

LEAK PROOF:

RFSSH hose assemblies have two pressure tight containment areas.

STRONG:

SSHT hose assemblies have a 500% greater fitting retention rate than assemblies made using a single weld process. We use twice as much welding material to create exceptionally strong assemblies.

LONG SERVICE LIFE:

Our forming process causes little work hardening of the base metal so our hose withstands more metal fatigue. We draw the corrugations into the hose instead of stretching the metal to form them.

RESISTANT TO VIBRATION AND STRESS:

We have achieved a uniform hose wall at critical stress points. This makes RFSSH far more durable.

SAFE:

RFSSH hose assemblies are pressure tested and subjected to separate quality checks. Our braid is made from 100,000 psi tensile strength wire per ASTM A580 for maximum safety.

PURE:

We use specified stainless steel welding rod to weld various grades of stainless steel. This makes our weld more corrosion resistant than the base stainless metal. We can argon purge our welds so that weld penetration is 100% and the weld is uniform and pure all the way through.

RFSSHT

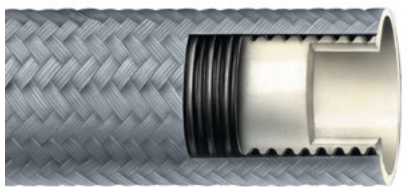

PTFE Lined Stainless Steel Corrugated Hose

TUBE: 316L corrugated stainless steel with seamless PTFE

321 corrugated stainless steel with seamless PTFE

COVER: Braided stainless steel

TEMPERATURE: -20°F to 350°F

RFSSH

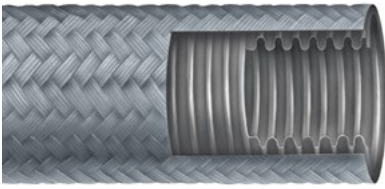

Stainless Steel Corrugated Hose

TUBE: 316L corrugated stainless steel
321 corrugated stainless steel

COVER: 304SS braided stainless steel

TEMPERATURE:

316L SS Core: -400°F to 800°F

321 SS Core: -400°F to 1500°F

See page XX for Temperature Correction Chart.

PART NUMBER KEY:

1 = No Outer Braid

2 = Single Outer Braid

3 = Double Outer Braid

This product is factory fabricated. Lengths longer than 10 feet, we do not deduct for fittings, making the hose longer than ordered. Please keep that in mind when ordering.

Features

- Available in no outer braid, 304SS single outer braid, and 304SS double outer braid for high pressure applications
- Hose inner core and outer braid are stainless steel
- Extremely flexible
- Size range: 1/4" to 14"
Consult factory for more information on availability for 16", 18", 20", 22", and 24" sizes
- Degreasing available

Applications

- High and low temperature
- Chemical transfer
- Continuous steam
- Vibration absorber
- Load cell

Hose Certifications

- Assemblies made in accordance with ISO 10380 standards for metal hose assemblies
- Meets NAHAD specifications

Part Number	Hose ID Inch	Hose OD Inch	Max. Working Pressure @ 70°F psig	Bend Radius Inch
04RFSSH1	0.25	0.40	145	4.0
04RFSSH2	0.25	0.45	2430	4.0
04RFSSH3	0.25	0.50	3190	4.0
06RFSSH1	0.375	0.59	80	6.0
06RFSSH2	0.375	0.64	1450	6.0
06RFSSH3	0.375	0.69	2580	6.0
08RFSSH1	0.50	0.77	80	6.0
08RFSSH2	0.50	0.83	1075	6.0
08RFSSH3	0.50	0.88	1500	6.0
12RFSSH1	0.75	1.02	60	8.0
12RFSSH2	0.75	1.08	950	8.0
12RFSSH3	0.75	1.14	1250	8.0
16RFSSH1	1.00	1.33	60	8.0
16RFSSH2	1.00	1.41	725	8.0
16RFSSH3	1.00	1.49	1110	8.0
20RFSSH1	1.25	1.62	50	10.0
20RFSSH2	1.25	1.70	563	10.0
20RFSSH3	1.25	1.78	825	10.0
24RFSSH1	1.50	1.88	35	10.0
24RFSSH2	1.50	1.95	500	10.0
24RFSSH3	1.50	2.05	800	10.0
32RFSSH1	2.00	2.45	15	13.0
32RFSSH2	2.00	2.53	478	13.0
32RFSSH3	2.00	2.61	638	13.0
40RFSSH1	2.50	3.23	12	20.0
40RFSSH2	2.50	3.33	387	20.0
40RFSSH3	2.50	3.43	619	20.0
48RFSSH1	3.00	3.78	10	22.0
48RFSSH2	3.00	3.88	316	22.0
48RFSSH3	3.00	3.98	506	22.0
64RFSSH1	4.00	4.85	8	27.0
64RFSSH2	4.00	4.98	232	27.0
64RFSSH3	4.00	5.10	371	27.0
80RFSSH1	5.00	5.90	6	31.0
80RFSSH2	5.00	6.03	191	31.0
80RFSSH3	5.00	6.15	306	31.0
96RFSSH1	6.00	6.87	5	36.0
96RFSSH2	6.00	7.10	165	36.0
96RFSSH3	6.00	7.33	264	36.0
128RFSSH1	8.00	9.09	6	40.0
128RFSSH2	8.00	9.19	234	40.0
128RFSSH3	8.00	9.28	374	40.0
160RFSSH1	10.00	11.18	5	50.0
160RFSSH2	10.00	11.32	230	50.0
192RFSSH1	12.00	13.23	3	60.0
192RFSSH2	12.00	13.37	161	60.0
224RFSSH1	14.00	14.60	17	70.0
224RFSSH2	14.00	15.00	110	70.0

METAL HOSE GLOSSARY OF TERMS

BEND RADIUS:

Constant Flexing: The minimum radius of a bend measured to the assembly's centerline to maximize assembly life and to be used in motion calculations.

Static Bend: The radius of a bend measured to the assembly's centerline to which an assembly may be bent for installation. The assembly should be subjected to no further motion other than vibration.

BRAID:

Tubular sheath of braided wires made to fit snugly over the hose and welded at the ends of the assembly. Braid is the pressure member of the assembly and prevents elongation of the corrugations under pressure.

CONSTRUCTION:

Annular: Convolutions that are a complete circle or ring.

Helical: Convolutions that are continuous and spiral along the length of the hose.

FAILURES (TYPICAL):

Abrasion: Failure caused by rubbing.

Braid Wear: Failure caused by motion between the braid and the corrugations.

Carbide Precipitation: Corrosion that occurs between dissimilar metals on the less noble of the metals.

Fatigue: Failure caused by flexing which results in the break down of the metal structure.

Squirm: Failure caused by excessive internal pressure that causes the corrugations to break out and shoot into an "S" OR "U" shape.

RFSSHT

Torque: Excessive twisting of the assembly causing metal fatigue and failure.

FLOW RATE:

The volume of media being conveyed in a given time period.

FREQUENCY:

The rate of vibration or flexure of an assembly in a given period of time.

HARMONIC RESONANCE:

The sympathetic vibration of convolutions caused by buffeting of the convolutions by a high velocity gas or steam flow.

LENGTH:

Live: The length of the exposed hose and braid excluding weld rings and fittings.

Overall: The total length of the assembly including end fittings.

MOTION:

Angular Motion: Motion that occurs when one end of an assembly is deflected in a simple bend. In these applications, care must be taken not to unload the braid by expansion.

Offset Motion: Motion that occurs when the ends of an assembly are displaced laterally to each other in a plane perpendicular to the longitudinal axis with the ends remaining parallel. The offset radius should never be greater than 25% of the minimum centerline bend radius.

Radial Motion: Motion that occurs when the centerline of the assembly is bent in a circular arc.

Random Motion: Motion that occurs non-cyclically as when an assembly is handled manually.

PRESSURE:

Pressure Drop: The amount of pressure lost by the medium as it travels through the hose. In long assemblies, pressure loss can be estimated to three times that of comparably sized pipe.

Maximum Working Pressure: The maximum operating pressure to which the hose assembly should be subjected to.

Burst Pressure: The pressure at which the hose assembly can be expected to rupture or the braid fail in tensile. This pressure is determined in a laboratory setting at 70°F and the hose installed in a straight line.

Deformation Pressure: The pressure at which the hose corrugations will permanently deform regardless of the external braiding.

Test Pressure: The maximum pressure a hose can be tested at before damage will occur. It is not recommended that hydrostatic testing be conducted above 120% of the maximum working pressure, or 150% of the actual operating pressure of the particular application, whichever is less.

Pulsating Pressure: A rapid change in pressure above and below the normal base pressure.

Shock Pressure: Also called surge pressure. A sudden increase in pressure, which causes a shock wave through the assembly.

NOTE: For applications that experience pulsating, shock, or surge pressures, the peak pressure should not exceed 50% of the maximum working pressure and the braid must be tight to the hose with no slack after installation.

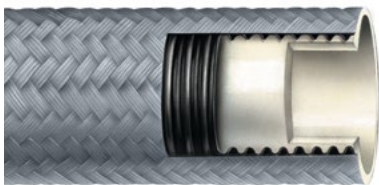

PTFE Lined Stainless Steel Corrugated Hose

TUBE: 316L corrugated stainless steel with seamless PTFE

321 corrugated stainless steel with seamless PTFE

COVER: Braided stainless steel

TEMPERATURE: -20°F to 350°F

Part Number	Hose ID Inch	Hose OD Inch	Bend Radius Inch	Max. Working Pressure @ 70°F psig	Vacuum Rating @ 70°F in. Hg.	Weight Per Foot Flanged Assembly	Weight Per Additional Foot
16RFSSHT	0.88	1.59	12	750	29	3.53	1.03
24RFSSHT	1.38	2.27	15	565	29	5.79	1.96
32RFSSHT	1.87	2.91	21	500	29	9.49	2.67
48RFSSHT	2.79	3.69	28	288	29	14.44	2.64
64RFSSHT*	3.76	4.84	46	250	20	21.57	3.17
96RFSSHT*	5.68	7.16	65	175	22	39.94	6.74
128RFSSHT*	7.71	9.31	89	212	20	62.50	9.50

* Available in 150# flange style only. Lengths longer than 10 feet, we do not deduct for fittings, making the hose longer than ordered. Please keep that in mind when ordering.

Features

- Smooth inner surface
- Bacteria free contact surface
- High purity
- Flare thru design eliminates metal corrosion and process contamination
- Available with optional 1/8" vent port

Applications

- High and low temperature
- Chemical transfer
- Continuous steam
- Vibration absorber
- Load cell

Hose Certifications

- Manufactured using FDA and 3-A compliant resin

End Fittings

- PTFE Flare thru 150# flange

Sight Glass

Sanitary sight glass assemblies are used widely in the food, dairy, beverage, biotech, pharmaceutical, and all other sanitary process industries to view products and fluids. Sanitary sight glass assemblies are placed inline with rigid pipe lines where product visibility is needed. Tank unloading, processing, and product transfer are a few of the many areas where sanitary sight glass assemblies are used inline with product transfer lines. Sanitary sight glass assemblies are available in a range of sight glass types including FEP, Polysulfone, and Pyrex®. Sanitary sight glass assembly end connections are available as radially crimped connections and unitized nonmetallic connections depending on the sight glass materials.

RFSG



Non-Caged FEP Sight Gauge

TEMPERATURE: -25°F to 300°F

END CONNECTIONS: 316L stainless steel sanitary Tri-Clamp®

RFCSG

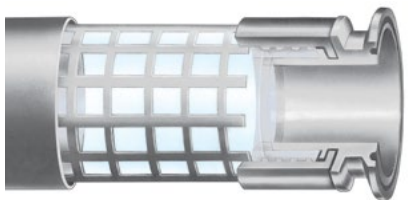

Caged FEP Sight Gauge

TEMPERATURE: -25°F to 300°F

END CONNECTIONS: 316L stainless steel sanitary Tri-Clamp®

RFPSSG



Polysulfone Sight Gauge

TEMPERATURE: -20°F to 240°F

MOLDED END CONNECTIONS: Mini Tri-Clamp®

RFBSG

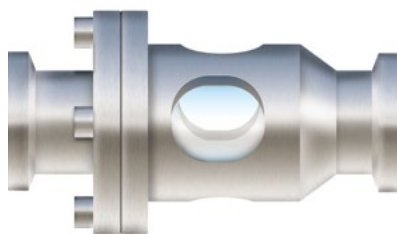

Bolted Sight Gauge

TEMPERATURE: Acrylic insert 180°F

Pyrex® insert is dependent on temperature rating of gasket used in fitting connection

RFACSG



Clear Acrylic Sight Tube

Made from ASTM 5436-D, FDA-conforming acrylic and can be clamped into sanitary lines seamlessly.

View Ports/ End Caps

Rubber Fab offers an array of View Port and end cap sight glass options.

View Ports

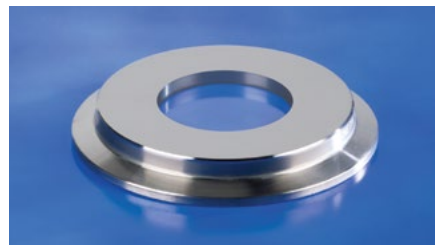

The strongest, most secure sanitary sight glass available, View Port's mechanically prestressed windows are available in a sanitary clamp design for sight ports in processing applications or inline visual flow indicators.

Acrylic End Caps



Rubber Fab offers acrylic sanitary fitting end caps for Bevel Seat, Tri-Clamp®, and I-Line fittings.

Polysulfone End Caps

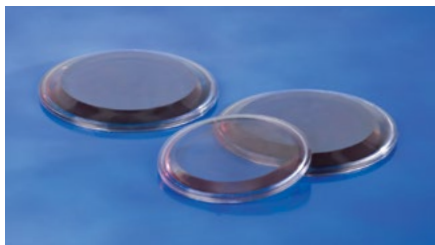

Rubber Fab offers polysulfone sanitary fitting end caps.

**Also available in Lexan*

RFSG



Non-Caged FEP Sight Gauge

TEMPERATURE: -25°F to 300°F

END CONNECTIONS: 316L stainless steel sanitary Tri-Clamp®
Consult factory for other end connection options

Note: ID is nominal bore only. Consult factory for fitting ID dimension.
Rubber Fab recommends a Rubber Fab factory crimp for this product.

Part Number	Hose ID Inch	Hose OD Inch	Wall Thickness	Max. Working Pressure @ 70°F
08RFSG	0.50	0.75	0.125	150 psi
12RFSG	0.75	1.00	0.125	130 psi
16RFSG	1.00	1.25	0.125	125 psi
24RFSG	1.50	1.75	0.125	105 psi
32RFSG	2.00	2.35	0.175	72 psi
40RFSG	2.37	2.65	0.140	50 psi
48RFSG	2.87	3.23	0.180	40 psi

Features

- Liquid level indicators
- Sturdy, favorable in high stress applications
- High and low temperature rated
- Smooth, non-stick surface cleans easily and promotes minimal pressure drop
- Non-contaminating
- Will not impart taste or odor
- Shatterproof tube
- Will not discolor
- Unaffected by ultraviolet or sunlight

Certifications

- 3-A Sanitary Standards
- USDA
- FDA
- USP Class VI



RFCSG

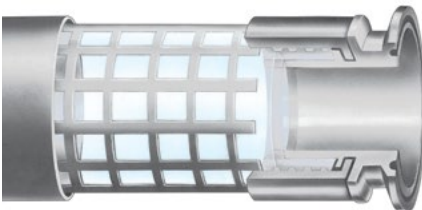

Caged FEP Sight Gauge

TEMPERATURE: -25°F to 300°F

END CONNECTIONS: 316L stainless steel sanitary Tri-Clamp®

Part Number	Hose ID Inch	Hose OD Inch	Wall Thickness	Max. Working Pressure @ 70°F
16RFCSG	1.00	1.25	0.125	250 psi
24RFCSG	1.50	1.75	0.125	200 psi
32RFCSG	2.00	2.35	0.175	100 psi

This product is factory fabricated.
Consult factory for individual length limits.

Features

- High pressure
- Liquid level indicators
- Sturdy, favorable in high stress applications
- High and low temperature rated
- Smooth, non-stick surface cleans easily and promotes minimal pressure drop
- Non-contaminating
- Will not impart taste or odor
- Shatterproof tube
- Will not discolor
- Unaffected by ultraviolet or sunlight

Certifications

- 3-A Sanitary Standards
- FDA 21 CFR 177.1550
- USDA
- USP Class VI



RFPSSG



Polysulfone Sight Gauge

TEMPERATURE: -20°F to 240°F

MOLDED END CONNECTIONS:
Mini Tri-Clamp®

Part Number	Hose ID Inch	Hose OD Inch	TC Size	Max. Working Pressure @ 70°F
08RFPSSG08TC08TCM	0.50	0.63	0.50	176 psi
24RFPSSG24TC24TCM	1.36	1.61	1.50	125 psi
32RFPSSG32TC32TCM	1.86	2.11	2.00	125 psi
40RFPSSG40TC40TCM	2.36	2.61	2.50	62 psi

This product is factory fabricated.

Features

- Light weight
- Perfect surface connection prevents bacteria trap

Certifications

- FDA 21 CFR 177.1655

RFBSG

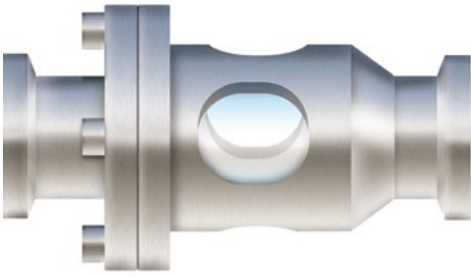

Bolted Sight Gauge

TEMPERATURE: Temperature rating for the borosilicate insert is dependent on temperature rating of gasket used in fitting connection. RFBSG comes standard with buna gasket and a temperature rating of 250°

Borosilicate insert: 250°F
Acrylic insert: 180°F

Part Number	ID Inch	OAL Inch	# of Bolts	Max. Working Pressure @ 70°F Pyrex PSI	Max. Working Pressure @ 70°F Acrylic PSI
08RFBSG	0.50	3.00	4	378	1400
12RFBSG	0.75	3.00	4	325	450
16RFBSG	1.00	3.63	4	215	439
24RFBSG	1.50	3.63	4	150	306
32RFBSG	2.00	3.63	4	130	234
40RFBSG	2.50	3.63	6	100	160
48RFBSG	3.00	3.63	6	95	234
64RFBSG	4.00	3.63	8	60	n/a
96RFBSG	6.00	4.63	8	33	n/a

This product is factory fabricated.

Features

- Provides fast, continuous inspection from all angles
- Available with borosilicate or acrylic inserts
- Includes buna gasket. Also available with FKM fluoroelastomer and silicone
- Bevel Seat, Buttweld, I-Line, or Q-Line end configurations available

Certifications

- 3-A Sanitary Standards



RFACSG



Clear Acrylic Sight Tubes

Made from ASTM 5436-D, FDA-conforming acrylic and can be clamped into sanitary lines seamlessly.

Not recommended for use with abrasive products. Do not use 2 bolt high-pressure clamps. Minimum length is 1.25" OAL

Part Number	Clamp Size	Length (inches)	Max. Cold Working Pressure PSI @70°F	Pressure PSI @ Max. Allowable Temp. @140°F	Inside Diameter (Reference ID)	Outside Diameter (Reference OD)
24RFACSG-5.875	1.5"	5.875	145	100	1.295"	2"
32RFACSG-5.875	2"	5.875	145	100	1.835"	2.625"
48RFACSG-7.50	3"	7.500	120	75	2.817"	3.625"
64RFACSG-7.625	4"	7.625	75	30	3.750"	4.750"

Note:

Standard length shown, other lengths available upon request. Maximum length for 1 1/2" and 2" sizes = 48". Maximum lengths for 3" and 4" sizes = 7.625"

Features

- Ideal for simple sight requirements as well as tank level indication
- Economical option to standard stainless steel sight glasses
- Standard clamp torque is required (25 in/lbs)
- Pressure ratings absent thermal shock

Certifications

- CFR 177.1010

View Ports



View Port sight glasses meet the USP Type 1 standard for pharmaceutical use.

Described as offering the optics of glass and the strength of steel, these glass elements provide a level of safety, and a useful service life, well beyond that provided by conventional tempered glass or plastic in sanitary service. Even at the most extreme temperatures (as high as 536° F) or in overpressure situations, sudden, total failure that involve leakage or explosive shattering of the glass, essentially never occurs.

AVAILABLE IN:

Sanitary Tri-Clamp®
Bevel Seat
I-Line

Part Number	d1 Inch	d2 Inch	d3 Inch	S Inch	psig @ 536°F
RFVP-075-2205DSS	0.98	0.71	0.39	0.39	230
RFVP-150-2205DSS	1.99	1.61	0.98	0.39	230
RFVP-200-2205DSS	2.52	2.05	1.18	0.39	200
RFVP-250-2205DSS	3.05	2.72	1.38	0.39	200
RFVP-300-2205DSS	3.58	2.99	1.57	0.39	150
RFVP-400-2205DSS	4.69	4.02	2.17	0.47	150
RFVP-600-2205DSS	6.57	5.98	2.95	0.63	90
RFVP-800-2205DSS	8.56	7.80	3.94	0.71	90
RFVP-1000-2205DSS	10.55	9.65	4.72	0.79	90
RFVP-1200-2205DSS	12.56	11.81	5.51	0.87	80

Note:

Temperature and pressure apply to View Port only.

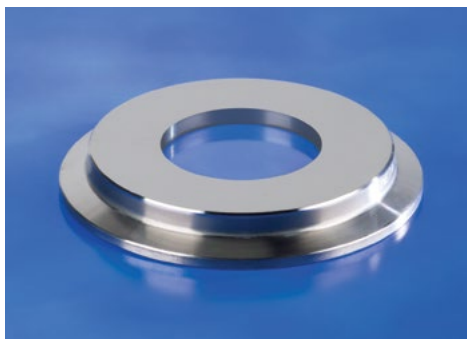
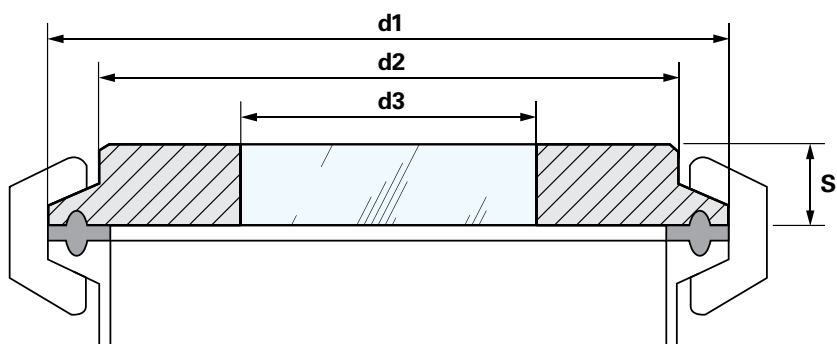

Applications

View Ports are manufactured to fit sanitary clamp connections. With simple, fast installation and no risk of breakage, this sleek, compact, one piece design provides a cleaner look, less bacteria traps, and unsurpassed safety. The View Port sight glass can be used as a viewable port mounted on a ferrule, a "cross" for inline visual flow indication or as a light port. Many other connection types are also available. Materials available include 2205 Duplex Stainless Steel, Hastelloy®, Monel®, and Inconel®.

Approvals & Technical Data

- USP Class VI (tested to confirm biocompatibility)
- BPE Compliant and TÜV Approved
- Sight glass fused to metal conforming to DIN7079
- Borosilicate glass to USP Type I and DIN7080
- Standard surface finish of 10 Ra μ-in (0.25μm)
- Material to ASTM/ASME, TÜV and DIN/EN standards
- Certificate of Conformity to EN 10204-3.1B or 3.1A
- Pressure Equipment Directive 97/23/EG

Acrylic and Lexan End Caps



Size Inch	Part Number	A Dimension	B Dimension	C Dimension
1	16AMP-100-XX	1.98	1.23	0.35
1-1/2	16AMP-150-XX	1.98	1.23	0.35
2	16AMP-200-XX	2.52	1.76	0.35
2-1/2	16AMP-250-XX	3.00	2.29	0.35
3	16AMP-300-XX	3.58	2.80	0.35
4	16AMP-400-XX	4.68	3.92	0.35
6	16AMP-600-XX	6.57	5.03	0.60
8	16AMP-800-XX	8.57	7.20	0.50
10	16AMP-1000-XX	10.57	9.20	0.50
12	16AMP-1200-XX	12.57	11.20	0.50

Replace XX with AC for Acrylic or LX for Lexan

Also available in Bevel Seat or I-Line styles.

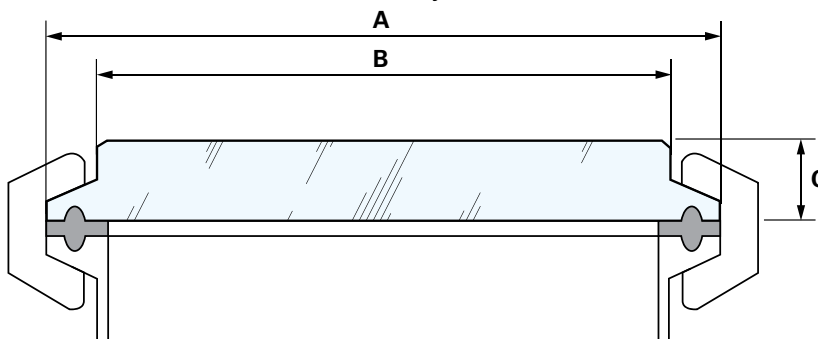

Polysulfone End Caps

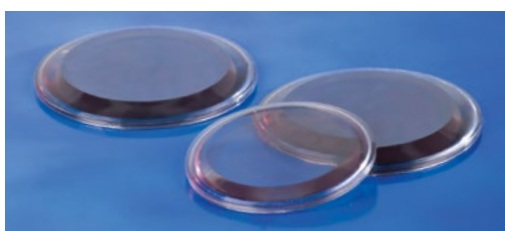

Size Inch	Part Number	A Dimension	B Dimension	C Dimension
1	16AMP-100-PS	1.98	1.23	0.35
1-1/2	16AMP-150-PS	1.98	1.23	0.35
2	16AMP-200-PS	2.52	1.76	0.35

Available in Bevel Seat or I-Line styles.

Metal Detection Tube

Rubber Fab's Metal Detection tubes are used as a metal detection machine component for viscous products such as liquids, slurries, syrups, pastes, and many other pumped products. When metal is detected in the product flow, a reject signal is channeled to one of the available output relays. The output relay can be used to activate a ball valve, control a visual or audio alarm, or send a signal to a PLC and release the rejected product, therefore minimizing product loss and costly downtime.

Size in Inches	Part Number
1-1/2	24RFKMD24TC24TCSS
2	32RFKMD32TC32TCSS
2-1/2	40RFKMD40TC40TCSS
3	48RFKMD48TC48TCSS
4	64RFKMD64TC64TCSS

Rubber Fab recommends a Rubber Fab factory crimp for this product.

Rubber Fab's sanitary metal detection tube assemblies are manufactured using steam cleanable USDA, FDA approved schedule 80 PVDF pipe suitable for system temperatures of -40°F to 240°F, and 316L sanitary Tri-Clamp® connections.

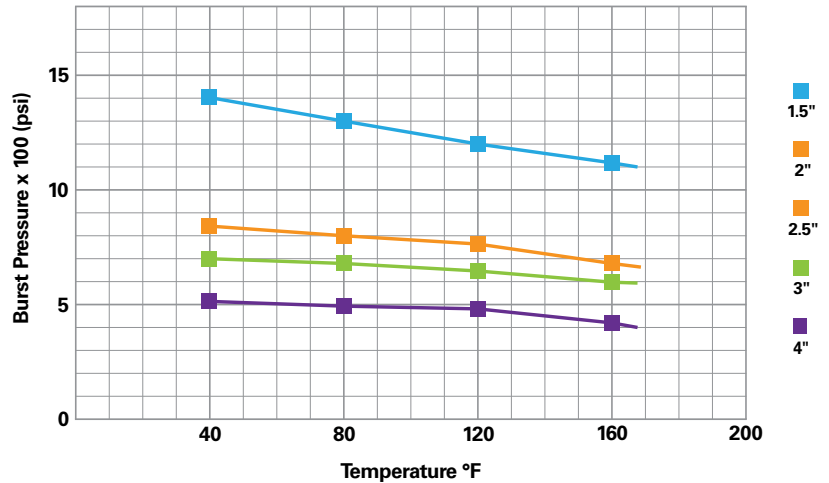

Notes:

- 1: Burst pressure based on tensile strength: $B.P. = 2(T.S. \times Wall)/OD$
- 2: To calculate working pressure, divide burst pressure by a safety factor of 3.
- 3: Pressure calculated for tubing only. Connections and ends must be calculated separately.

Laser Engraved Connections Available



Silicone Hose

Rubber Fab's high purity platinum-cured and peroxide-cured silicone hoses are clean room produced for critical pharmaceutical, medical, cosmetic, and food applications.

RFSB

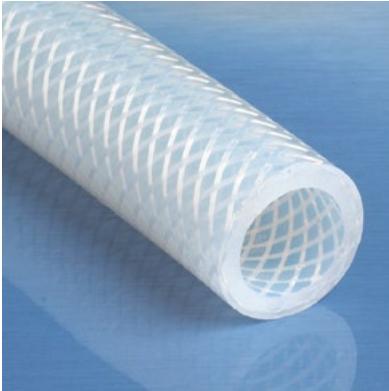

Smoothbore Platinum Cured Silicone Hose with Braid Reinforcement

TUBE: Smoothbore platinum cured silicone

COVER: Platinum cured silicone

REINFORCEMENT: Polyester braid

COLOR: Translucent

TEMPERATURE: -100°F to 350°F

RFSBHP



Smoothbore Platinum Cured High Pressure Silicone Hose with Double Braid Reinforcement

TUBE: Smoothbore platinum cured silicone

COVER: Smoothbore white platinum silicone

REINFORCEMENT: Polyester braid

COLOR: White

TEMPERATURE: -100°F to 350°F

RFSV



Smoothbore Platinum Cured Silicone Hose with Wire Reinforcement

TUBE: Smoothbore platinum cured silicone

COVER: Platinum cured silicone

REINFORCEMENT: 4-Ply, polyester braid with stainless steel helix wire

COLOR: Translucent white

TEMPERATURE: -100° to 350°F

RFSBX



Smoothbore Peroxide Cured Silicone Hose with Braid Reinforcement

TUBE: Smoothbore peroxide cured silicone

COVER: Peroxide cured silicone

REINFORCEMENT: Polyester braid

COLOR: Translucent

TEMPERATURE: -80°F to 350°F

RFS4P



Smoothbore Platinum Cured Silicone Hose with 4-Ply Reinforcement

TUBE: Smoothbore platinum cured silicone

COVER: Platinum cured silicone

REINFORCEMENT: 4-Ply polyester braid

COLOR: Translucent white

TEMPERATURE: -100°F to 350°F

RFSVOC



Smoothbore Platinum Cured Silicone Hose with Wire Reinforcement and Silicone Outer Convuluted Cover

TUBE: Smoothbore platinum cured silicone

COVER: Corrugated platinum cured silicone

REINFORCEMENT: 4-Ply, polyester braid with stainless steel helix wire

COLOR: Translucent white

TEMPERATURE: -100° to 350°F

RFSB

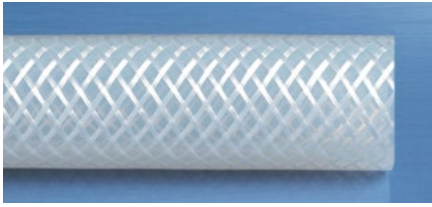

Smoothbore Platinum Cured Silicone Hose with Braid Reinforcement

TUBE: Smoothbore platinum cured silicone

COVER: Platinum cured silicone

REINFORCEMENT: Polyester braid

COLOR: Translucent

TEMPERATURE: -100°F to 400°F

Part Number	Hose ID Inch	Hose OD Inch	Bend Radius Inch	Max. Working Pressure @ 70°F psig	Weight Per Foot
04RFSB	0.25	0.50	1.00	140	0.08
06RFSB	0.38	0.63	1.00	140	0.10
08RFSB	0.50	0.88	3.00	105	0.21
10RFSB	0.63	0.99	3.00	100	0.24
12RFSB	0.75	1.13	4.00	90	0.29
16RFSB	1.00	1.41	6.00	60	0.40

RFSB is manufactured in 25 and 50 foot lengths.

Features

- Ultra flexible
- Hardness value 65 Shore A
- Sterilizable by autoclave, CIP, SIP (up to 15 PSI of steam), and gamma radiation processes
- Will not impart taste or odor
- Clean room manufactured
- Non-toxic
- Non-pyrogenic
- Lot and batch traceable
- Resists temperature extremes and ozone

Applications

- Pharmaceutical processing
- Bio medical
- Laboratory
- Cosmetic
- Peristaltic pump applications
- Ultra pure liquid transfer
- Food processing
- Wash down stations
- Skid systems
- Veterinary pharmaceuticals
- Load cell applications
- Pharmaceutical skid transfer

Hose Certifications

- USP Class VI
- European Pharmacopoeia 3.1.9
- FDA 21 CFR 177.2600
- 3-A Sanitary Standards
- NSF 51 Core
- ISO 10993
- ADI Free®



RFSBX

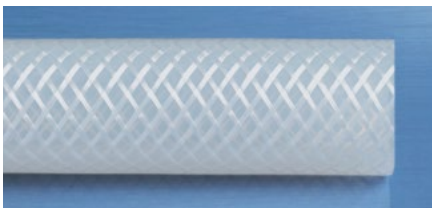

Smoothbore Peroxide Cured Silicone Hose with Braid Reinforcement

TUBE: Smoothbore peroxide cured silicone

COVER: Peroxide cured silicone

REINFORCEMENT: Polyester braid

COLOR: Translucent

TEMPERATURE: -80°F to 350°F

Part Number	Hose ID Inch	Hose OD Inch	Bend Radius Inch	Max. Working Pressure @ 70°F psig	Weight Per Foot
04RFSBX	0.25	0.52	1.00	208	0.09
06RFSBX	0.38	0.66	3.00	166	0.13
08RFSBX	0.50	0.80	3.00	141	0.17
12RFSBX	0.75	1.10	5.00	91	0.28
16RFSBX	1.00	1.38	6.00	75	0.36

RFSBX is manufactured in 25 and 50 foot lengths. Medical Grade is available, please consult factory for price.

Features

- Open mesh polyester braiding incorporated within the walls of silicone hose
- Translucent natural color for visual contact with the flow
- Will not impart taste or odor
- All ingredients are non-toxic and FDA sanctioned for use with food contact surfaces

Applications

- Adhesive lines
- Beverage service
- Bottle filling
- Chemical feeds
- Deionized water transfer
- Fermenter lines
- Hot fill lines
- Food handling
- Laboratory
- Resin feeds
- Stirring vessels
- Viscous material handling

Hose Certifications

- FDA 21 CFR 177.2600
- 3-A Sanitary Standards
- Meets NSF 51 requirements
- FDA sanctioned for use with food contact surfaces
- ADI Free®



RFSBHP

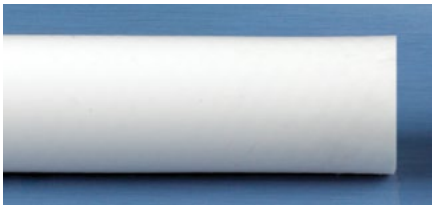

Smoothbore Platinum Cured High Pressure Silicone Hose with Double Braid Reinforcement

TUBE: Smoothbore platinum cured silicone

COVER: Smoothbore platinum silicone

REINFORCEMENT: Polyester braid

COLOR: White

TEMPERATURE: -100°F to 350°F

Part Number	Hose ID Inch	Hose OD Inch	Bend Radius Inch	Max. Working Pressure @ 70°F psig	Weight Per Foot
08RFSB-HP	0.50	0.89	2.50	150	0.21
12RFSB-HP	0.75	1.18	3.00	188	0.29
16RFSB-HP	1.00	1.43	3.50	125	0.40

RFSBHP is manufactured in 25 and 50 foot lengths.

Features

- Smoothbore with braid reinforcement for increased working pressures
- Superior flexibility
- Sterilizable/autoclavable
- Will not impart taste or odor
- Lot and batch traceability
- Resists temperature extremes, ozone radiation, moisture, and environmental exposure
- Hardness value: core - 70 Shore A, outer cover - 60 Shore A
- Cleanroom manufactured and packaged

Applications

- Pharmaceutical skid transfer
- Pharmaceutical processing
- Load cell
- Vessel or tank transfer
- Media dispensing
- Laboratory use
- Water for injection (WFI)
- Bioreactor process lines
- Cosmetic processing
- Pump cultures

Hose Certifications

- USP Class VI
- European Pharmacopoeia 3.1.9
- FDA 177.2600
- 3-A Sanitary Standards
- NSF 51
- ISO 10993
- ADI Free®



RFS4P



Smoothbore Platinum Cured Silicone Hose with 4-Ply Reinforcement

TUBE: Smoothbore platinum cured silicone

COVER: Platinum cured silicone

REINFORCEMENT: 4-Ply polyester braid

COLOR: Translucent white

TEMPERATURE: -100°F to 350°F

Part Number	Hose ID Inch	Hose OD Inch	Bend Radius Inch	Max. Working Pressure @ 70°F psig	Burst Pressure @ 70°F psig	Weight Per Foot
08RFS4P	0.50	0.92	2.50	150	600	0.28
12RFS4P	0.75	1.17	4.50	150	600	0.36
16RFS4P	1.00	1.42	9.00	150	600	0.44
24RFS4P	1.50	1.92	12.00	150	600	0.69
32RFS4P	2.00	2.42	CF	125	500	0.88
40RFS4P	2.50	2.92	CF	125	500	1.05
48RFS4P	3.00	3.42	CF	100	400	1.23
64RFS4P	4.00	4.42	CF	100	400	CF

1/2" is manufactured in 13.12' lengths. 3/4" - 2" is manufactured in 19.685' lengths. 3" - 4" is manufactured in 13.12' lengths. CF = Consult Factory

Features

- Ultra flexible
- Sterilizable by autoclave, CIP, SIP, and gamma radiation processes
- Hardness value of 70 Shore A
- Will not impart taste or odor
- Clean room manufactured
- Non-toxic
- Non-pyrogenic
- Lot and batch traceable
- Resists temperature extremes and ozones

Applications

- Food processing
- Medical/surgical applications
- Dairy
- Beverage
- Fermentation
- Biotechnology
- Pharmaceutical processing
- Load cells
- Cell cultures
- WFI transfer
- Pump applications
- Not intended for steam applications

Hose Certifications

- USP Class VI
- European Pharmacopoeia 3.1.9
- FDA 21 CFR 177.2600
- 3-A Sanitary Standards
- ADI Free®



RFSV

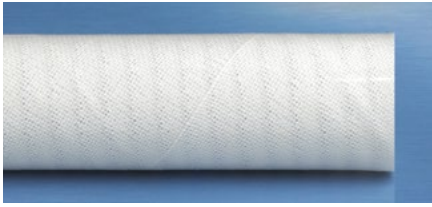

Smoothbore Platinum Cured Silicone Hose with Wire Reinforcement

TUBE: Smoothbore platinum cured silicone

COVER: Platinum cured silicone

REINFORCEMENT: 4-Ply, polyester braid with stainless steel helix wire

COLOR: Translucent white

TEMPERATURE: -100°F to 350°F

Part Number	Hose ID Inch	Hose OD Inch	Bend Radius Inch	Max. Working Pressure @ 70°F psig	Vacuum Rating @ 70°F in. Hg.	Weight Per Foot
08RFSV	0.500	0.886	2.00	150	FULL	0.28
12RFSV	0.750	1.134	2.50	150	FULL	0.36
16RFSV	1.000	1.386	3.50	150	FULL	0.44
24RFSV	1.500	1.886	4.00	150	FULL	0.69
32RFSV	2.000	2.386	6.00	125	FULL	0.88
40RFSV	2.500	2.988	11.00	125	FULL	1.05
48RFSV	3.000	3.488	13.00	100	CF	1.23
64RFSV	4.000	4.488	CF	100	CF	1.71

1/2" is manufactured in 13.12' lengths. 3/4" - 2" is manufactured in 19.685' lengths. 3" - 4" is manufactured in 13.12' lengths. CF = Consult Factory

Features

- Ultra flexible
- Sterilizable by autoclave, CIP, SIP, and gamma radiation processes
- Hardness value 70 Shore A
- Will not impart taste or odor
- Clean room manufactured
- Non-toxic
- Non-pyrogenic
- Lot and batch traceable
- Resists temperature extremes and ozones

Applications

- Pharmaceutical processing
- Bio medical
- Laboratory
- Cosmetic
- Ultra pure liquid transfer
- Food processing
- Wash down stations
- Veterinary pharmaceuticals
- Load cell applications
- Pharmaceutical skid transfer

Hose Certifications

- USP Class VI
- European Pharmacopoeia 3.1.9
- FDA 21 CFR 177.2600
- 3-A Sanitary Standards
- NSF 51 Core
- ISO 10993
- ADI Free®



RFSVOC

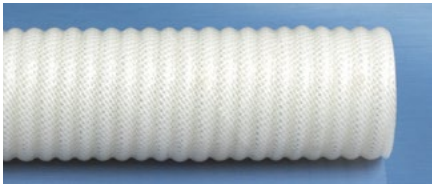

Smoothbore Platinum Cured Silicone Hose with Wire Reinforcement and Silicone Outer Convoluted Cover

TUBE: Smoothbore platinum cured silicone

COVER: Corrugated platinum cured silicone

REINFORCEMENT: 4-Ply, polyester braid with stainless steel helix wire

COLOR: Translucent white

TEMPERATURE: -100°F to 350°F

Part Number	Hose ID Inch	Hose OD Inch	Bend Radius Inch	Max. Working Pressure @ 70°F psig	Vacuum Rating @ 70°F in. Hg.	Weight Per Foot
08RFSVOC	0.50	0.91	2.00	150	FULL	0.21
12RFSVOC	0.75	1.16	2.50	150	FULL	0.31
16RFSVOC	1.00	1.41	3.50	150	FULL	0.39
24RFSVOC	1.50	1.91	4.00	150	FULL	0.63
32RFSVOC	2.00	2.41	6.00	125	FULL	0.78

1/2" is manufactured in 13.12' lengths. 3/4" - 2" is manufactured in 19.685' lengths. CF = Consult Factory

Features

- Smooth inner bore
- Ultra flexible
- Sterilizable by autoclave, CIP, SIP, and gamma radiation
- Hardness value of 70 Shore A
- Will not impart taste or odor
- Clean room manufactured
- Non-toxic
- Non-pyrogenic
- Lot and batch traceable
- Resists temperature extremes and ozones

Applications

- Pharmaceutical processing
- Biomedical
- Laboratory
- Cosmetic
- Ultra pure liquid transfer
- Food processing
- Wash down stations
- Skid systems
- Veterinary pharmaceuticals
- Load cell applications

Hose Certifications

- USP Class VI
- European Pharmacopoeia 3.1.9
- FDA 21 CFR 177.2600
- 3-A Sanitary Standards
- NSF 51 Core
- ISO 10993
- ADI Free®



FDA PVC Hose

Rubber Fab FDA PVC hoses are designed to transport a wide variety of fluids without imparting odor or taste. Non-toxic, non-pyrogenic, and alkaline resistant, these features render our hoses ideal for food/beverage, laboratory, and surgical/hospital applications.

RFPB



FDA Smoothbore PVC Hose with Braid Reinforcement

TUBE: Smoothbore FDA PVC

COVER: Smoothbore FDA PVC

REINFORCEMENT: Polyester textile inner braid

COLOR: Transparent

TEMPERATURE: 25°F to 150°F

RFPVV

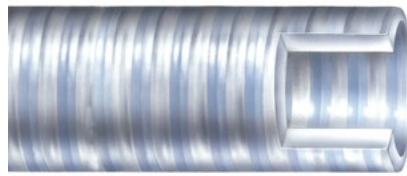

Smoothbore FDA PVC Hose with Spiral PVC Reinforcement

TUBE: Smoothbore FDA PVC

COVER: Smoothbore FDA PVC

REINFORCEMENT: Clear PVC helical reinforcement

COLOR: Translucent

TEMPERATURE: 25°F to 150°F

RFPVW

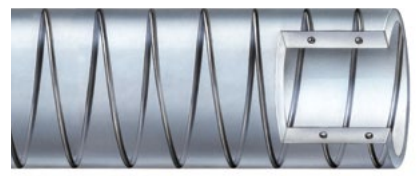

Smoothbore FDA PVC Hose with Wire Reinforcement

TUBE: Smoothbore FDA PVC

COVER: Smoothbore FDA PVC

REINFORCEMENT: Steel wire reinforcement

COLOR: Transparent

TEMPERATURE: 25°F to 150°F

RFPC

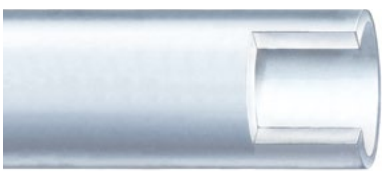

Smoothbore FDA PVC Hose

TUBE: Smoothbore FDA PVC

COVER: Smoothbore FDA PVC

COLOR: Transparent

TEMPERATURE: 25°F to 150°F

RFPBW



Smoothbore FDA PVC Hose with Braid and Wire Reinforcement

TUBE: Smoothbore FDA PVC

COVER: Smoothbore FDA PVC

REINFORCEMENT: Polyester textile inner braid and steel wire reinforcement

COLOR: Transparent

TEMPERATURE: 15°F to 150°F

In addition to bulk hose and crimped assemblies, Rubber Fab also offers PVC hose assemblies with hytrel unitized ends.



RFPB

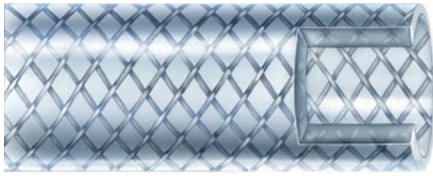

FDA Smoothbore PVC Hose with Braid Reinforcement

TUBE: Smoothbore FDA PVC

COVER: Smoothbore FDA PVC

REINFORCEMENT: Polyester textile inner braid

COLOR: Transparent

TEMPERATURE: 25°F to 150°F

Part Number	Hose ID Inch	Hose OD Inch	Max. Working Pressure @ 70°F psig	Weight Per Foot
02RFPB	0.13	0.33	350	0.04
03RFPB*	0.19	0.41	350	0.06
04RFPB	0.25	0.50	350	0.08
05RFPB*	0.31	0.56	275	0.09
06RFPB	0.38	0.63	275	0.11
08RFPB	0.50	0.81	250	0.17
10RFPB	0.63	1.00	225	0.26
12RFPB	0.75	1.13	200	0.30
16RFPB	1.00	1.38	150	0.38
20RFPB*	1.25	1.75	125	0.64
24RFPB	1.50	2.00	100	0.75
32RFPB	2.00	2.50	75	0.96

* Bulk hose only.

Features

- Will not impart taste or odor
- Non-toxic
- Non-pyrogenic
- Alkaline resistant
- Clear and flexible
- Available in bulk or fabricated assemblies

Applications

- Chemical processing and transfer
- Pharmaceutical manufacturing
- Food and syrup handling
- Beverage transfer
- Dairy processing
- Air lines
- Pump feed and discharge
- Laboratory and research
- Instrumentation
- General water suction and discharge
- Irrigation systems
- Hydraulics and pneumatics
- Spray systems
- Filters

Hose Certifications

- Meets FDA CFR Title 21 170-199
- 3-A Sanitary Standards
- Phthalate Free
- NSF 51
- RoHS
- USDA
- USP Class VI



RFPB – Food Grade PVC Braided Hose Assembly with Unitized Ends



Part Number	Hose ID Inch	Hose OD Inch	Tri-Clamp® Size	FPT Size	MPT Size	Working Pressure*
02RFPB	0.13	0.33	Mini	N/A	N/A	350
04RFPB	0.25	0.50	Mini & 1	1/2	1/4 & 1/2	350
06RFPB	0.38	0.63	Mini & 1	3/8	1/2	275
08RFPB	0.50	0.75	Mini, 1 & Maxi	1/2	1/2	250
10RFPB	0.63	0.88	Mini & 1	N/A	N/A	225
12RFPB	0.75	1.13	1 & Maxi	N/A	3/4 & 1	200
16RFPB	1.00	1.38	1-1/2 & 2	N/A	N/A	150
20RFPB	1.25	1.63	1-1/2	N/A	N/A	125
24RFPB	1.50	2.00	2	N/A	2	100
1856RFPB	1.86	2.37	2 & 2-1/2	N/A	N/A	75
32RFPB	2.00	2.50	2-1/2	N/A	N/A	75

*at 68°F

Note:

Safety factor of 3:1 working pressure for tubing only.

The fittings chart above reflects molded, unitized connections only. Consult factory for assembly part numbers. Also available stainless steel crimped connections, I-Line, Q-Line, and Bevel Seat with nut.

RFPVV



Smoothbore FDA PVC Hose with Spiral PVC Reinforcement

TUBE: Smoothbore FDA PVC

COVER: Smoothbore FDA PVC

REINFORCEMENT: Clear PVC helical reinforcement

COLOR: Translucent

TEMPERATURE: 25°F to 150°F

Part Number	Hose ID Inch	Hose OD Inch	Bend Radius Inch	Max. Working Pressure @ 70°F psig	Vacuum Rating @ 70°F in. Hg.	Weight Per Foot
12RFPVV	0.75	0.94	3.00	105	28	0.20
16RFPVV	1.00	1.25	3.00	100	28	0.27
20RFPVV*	1.25	1.50	3.00	95	28	0.30
24RFPVV	1.50	1.81	4.00	85	28	0.40
32RFPVV	2.00	2.38	5.00	80	28	0.60
40RFPVV	2.50	2.88	7.00	75	28	0.85
48RFPVV	3.00	3.44	8.00	65	28	1.15
64RFPVV	4.00	4.50	10.00	50	28	1.75
80RFPVV*	5.00	5.51	28.00	40	28	2.41
96RFPVV	6.00	6.59	48.00	30	28	3.28
128RFPVV	8.00	8.85	60.00	25	28	5.67

* Bulk hose only.

Features

- Will not impart taste or odor
- Non-toxic
- Non-pyrogenic
- Alkaline resistant
- Flexible
- Available in bulk or fabricated assemblies

Applications

- Chemical processing and transfer
- Pharmaceutical manufacturing
- Food and syrup handling
- Beverage transfer
- Dairy processing
- Air lines
- Pump feed and discharge
- Laboratory and research
- Instrumentation
- General water suction and discharge
- Irrigation systems
- Vacuum lines
- Hydraulics and pneumatics
- Spray systems
- Filters

Hose Certifications

- Meets FDA CFR Title 21 170-199
- Meets 3-A Sanitary Standards
- Meets USDA
- Phthalate Free



RFPVV – PVC Spiral Reinforced Assembly with Unitized Ends



Part Number	Hose ID Inch	Hose OD Inch	Tri-Clamp® Size	Working Pressure*
40RFPVV	2.50	2.88	3	75

*at 68°F

Note:

Safety factor of 3:1 working pressure for tubing only.

The fittings chart above reflects molded, unitized connections only.

Consult factory for assembly part numbers.

Also available stainless steel crimped connections, I-Line, Q-Line, and Bevel Seat with nut.

RFPVW



Smoothbore FDA PVC Hose with Wire Reinforcement

TUBE: Smoothbore FDA PVC

COVER: Smoothbore FDA PVC

REINFORCEMENT: Steel wire reinforcement

COLOR: Transparent

TEMPERATURE: 25°F to 150°F

Part Number	Hose ID Inch	Hose OD Inch	Bend Radius Inch	Max. Working Pressure @ 70°F psig	Vacuum Rating @ 70°F in. Hg.	Weight Per Foot
04RFPVW	0.25	0.46	1.00	150	FULL	0.07
06RFPVW	0.38	0.60	1.50	100	FULL	0.11
08RFPVW	0.50	0.75	2.00	100	FULL	0.15
10RFPVW	0.63	0.89	2.50	50	FULL	0.19
12RFPVW	0.75	1.03	3.00	70	FULL	0.24
16RFPVW	1.00	1.30	4.00	100	FULL	0.44
20RFPVW*	1.25	1.61	5.00	70	FULL	0.50
24RFPVW	1.50	1.86	6.00	50	FULL	0.58
32RFPVW	2.00	2.39	8.00	50	FULL	0.84
36RFPVW*	2.25	2.75	9.00	50	FULL	1.16
40RFPVW	2.50	3.00	10.00	50	FULL	1.38
48RFPVW	3.00	3.50	12.00	50	FULL	1.62

* Bulk hose only.

Features

- Clear and flexible
- Will not impart taste or odor
- Non-toxic
- Non-pyrogenic
- Alkaline resistant
- Available in bulk or fabricated assemblies
- Static grounding available

Applications

- Chemical processing and transfer
- Pharmaceutical manufacturing
- Food and syrup handling
- Beverage transfer
- Dairy processing
- Air lines
- Laboratory and research
- Instrumentation
- General water suction and discharge
- Irrigation systems
- Hydraulics and pneumatics

Hose Certifications

- USP Class VI
- FDA CFR Title 21 170-199
- 3-A Sanitary Standards
- NSF/ANSI STD 51
- RoHS
- USDA
- Phthalate Free



RFPVW – Food Grade PVC Wire Reinforced Vacuum Hose Assembly with Unitized Ends



Part Number	Hose ID Inch	Hose OD Inch	Tri-Clamp® Size	FPT Size	MPT Size	Working Pressure*
06RFPVW	0.38	0.63	Mini & 1	3/8	1/2	150
08RFPVW	0.50	0.75	Mini & 1	1/2	1/2	150
10RFPVW	0.63	0.88	Mini & 1	N/A	N/A	150
12RFPVW	0.75	1.00	1 & Maxi	N/A	3/4 & 1	150
16RFPVW	1.00	1.25	1-1/2 & 2	N/A	N/A	100
20RFPVW	1.25	1.56	1-1/2	N/A	N/A	100
24RFPVW	1.50	1.89	2	N/A	2	100
32RFPVW	2.00	2.36	2-1/2	N/A	N/A	100

*at 68°F

Note:

Safety factor of 3:1 working pressure for tubing only.

The fittings chart above reflects molded, unitized connections only. Consult factory for assembly part numbers.

Also available stainless steel crimped connections, I-Line, Q-Line, and Bevel Seat with nut.

RFPC



Smoothbore FDA PVC Hose

TUBE: Smoothbore FDA PVC

COVER: Smoothbore FDA PVC

COLOR: Transparent

TEMPERATURE: 25°F to 150°F

Features

- Phthalate free
- Non-pyrogenic and non-hemolytic
- Ultra smooth interior
- Superior flexibility
- Lot and batch traceable
- Contains no BPA
- Excellent chemical resistance
- Lot-to-lot consistency for reproducible results
- Slips easily over fittings and grips securely
- Available: bulk, spooled, with molded or crimped ends

Applications

- Laboratory research
- Analytical instruments
- Peristaltic and vacuum pumps
- Food and beverage
- Pharmaceuticals
- Biologics
- Medical device
- Brewery consumer products
- Environmental
- Raw milk
- Consumer products
- Ideal for condensers, incubators, desiccators, gas lines, and drain lines

Quality Standards

- USP Class VI
- FDA 21 CFR Part 175.300
- FDA 21 CFR Part 181.27
- FDA 21 CFR Part 178.2010
- FDA 21 CFR Part 178.3297
- Meets 3-A Sanitary Standards
- ADI Free®
- REACH Compliant
- RoHS Compliant
- Meets USDA

Part Number	ID Inch	OD Inch	Wall Inch	Bend Radius Inch	Max WP @ 72°F psig	Vacuum Rating @ 72°F in. Hg.	Weight Per 50 Foot Coil
RFPC-125-187	1/8	3/16	1/32	1/2	44	25.0	0.41
RFPC-125-250	1/8	1/4	1/16	3/8	68	29.9	0.99
RFPC-156-218	5/32	7/32	1/32	3/4	38	15.0	0.49
RFPC-156-250	5/32	1/4	3/64	1	CF	20.0	0.81
RFPC-170-250	.170	.250	.04	CF	42	CF	0.71
RFPC-187-312	3/16	5/16	1/16	5/8	55	29.9	1.32
RFPC-187-375	3/16	3/8	3/32	1/2	70	29.9	2.25
RFPC-187-437	3/16	7/16	1/8	3/8	80	29.9	3.30
RFPC-240-370	.240	.370	.065	CF	CF	CF	1.67
RFPC-250-375	1/4	3/8	1/16	1	55	25.0	1.65
RFPC-250-437	1/4	7/16	3/32	3/4	60	29.9	2.72
RFPC-250-500	1/4	1/2	1/8	5/8	70	29.9	4.00
RFPC-312-437	5/16	7/16	1/16	1-3/8	50	15.0	1.98
RFPC-375-500	3/8	1/2	1/16	1-3/4	40	10.0	2.32
RFPC-375-562	3/8	9/16	3/32	1-3/8	50	25.0	3.70
RFPC-375-625	3/8	5/8	1/8	1-1/8	65	29.9	5.28
RFPC-437-625	7/16	5/8	3/32	1-3/4	45	18.0	4.22
RFPC-500-625	1/2	5/8	1/16	2-7/8	30	6.0	2.97
RFPC-500-687	1/2	11/16	3/32	2-1/8	40	15.0	4.69
RFPC-500-750	1/2	3/4	1/8	1-3/4	45	25.0	6.60
RFPC-500-1000	1/2	1	1/4	2-1/2	67	29.9	15.83
RFPC-562-750	9/16	3/4	3/32	2-1/2	40	10.0	5.21
RFPC-625-875	5/8	7/8	1/8	2-3/8	40	15.0	7.92
RFPC-625-1000	5/8	1	3/16	2	49	25.0	12.86
RFPC-687-937	11/16	15/16	1/8	1-3/4	35	21.0	8.60
RFPC-750-1000	3/4	1	1/8	3-1/4	35	10.0	9.23
RFPC-750-1062	3/4	1-1/16	5/32	4	40	15.0	11.96
RFPC-750-1125	3/4	1-1/8	3/16	4-1/2	40	13.0	14.80
RFPC-875-1125	7/8	1-1/8	1/8	4-1/8	30	10.0	10.56
RFPC-1000-1125	1	1-1/8	1/16	3-1/2	18	5.0	5.61
RFPC-1000-1250	1	1-1/4	1/8	5-1/8	28	5.0	11.88
RFPC-1000-1375	1	1-3/8	3/16	5-1/2	45	8.0	18.80

CF = Consult Factory

RFPBW



Smoothbore FDA PVC Hose with Braid and Wire Reinforcement

TUBE: Smoothbore FDA PVC

COVER: Smoothbore FDA PVC

REINFORCEMENT: Polyester textile inner braid and steel wire reinforcement

COLOR: Transparent

TEMPERATURE: 15°F to 150°F

Part Number	Hose ID Inch	Hose OD Inch	Bend Radius Inch	Max. Working Pressure @ 70°F psig	Standard Length Coils in ft	Weight Per Pkg (lbs)
08RFPBW	0.50	0.906	2.00	250	25/25/100	6.5/13/26
12RFPBW	0.75	1.196	2.50	225	25/50/100	10/20/40
16RFPBW	1.00	1.464	3.50	225	25/50/100	13.3/26.5/53
20RFPBW	1.25	1.780	4.50	175	25/50	18.5/37
24RFPBW	1.50	2.030	5.50	175	25/50	21.5/43
32RFPBW	2.00	2.600	7.00	150	25/50	32/64

Features

- Kink resistant
- Non-marking
- Self-extinguishing
- Chemical resistant
- Available in standard coil lengths

Applications

- Chemical processing and transfer
- Air lines
- Water transfer
- Liquid food transfer
- Pressure and vacuum

Hose Certifications

- Meets FDA CFR Title 21 170-199
- Meets 3-A Sanitary Standards
- Meets USDA
- Phthalate Free



Unitized Ends

Unitized molded ends provide state-of-the-art sanitary connective technology due to its barbless, crevice-free smooth inner bore construction. The smooth I.D. eliminates bacteria traps and assures maximum, free flow. Non-metallic, platinum-cured silicone sanitary ends provide a built-in male sanitary gasket, eliminating the need for an independent gasket which can be difficult to align during installation.



Mini Tri-Clamp®



Tri-Clamp®

PFA Tubing

PFA is the tubing of choice for applications involving extreme chemical resistance combined with high temperature exposure. PFA tubing is suitable for even the most demanding applications.

Temperature

-300°F to 500°F

Features

- 100% virgin grade high performance resins used to resist stress cracking
- Chemically inert to nearly all industrial chemicals and solvents
- Higher thermal stability than with FEP
- Lower permeability than with FEP
- Translucent
- Moisture absorption nearly zero
- FDA compliant for food contact
- Non-flammable
- Tubing is suitable for use with flare or conventional fittings
- Tubing is available in coiled hose and convoluted constructions
- Low permeation PFA tubing and pipe are also available

Applications

- Chemical process
- Heat exchangers
- Laboratory
- Semiconductor
- Flow monitoring
- Emissions monitoring
- Double containment systems
- Food processing
- Electrical insulation

Packaging

- Per customer's specifications
- Clean room packed
- Available pre-flared and pre-cut

Certifications

- PFA is approved for use in food contact applications in compliance with FDA 21 CFR 177.1550
- PFA tubing meets or exceeds the requirements listed in ASTM D 6867-03
- USP Class VI

Standard Wall Tubing Part Number	ID Inch	OD Inch	Wall Inch	Bend Radius Inch	Max WP @ 72°F psig
RFPFA-062-125	1/16	1/8	1/32	1/2	449
RFPFA-093-156	3/32	5/32	1/32	1/2	360
RFPFA-125-187	1/8	3/16	1/32	3/4	299
RFPFA-187-250	3/16	1/4	1/32	1	225
RFPFA-250-312	1/4	5/16	1/32	1-3/4	179
RFPFA-312-375	5/16	3/8	1/32	2-1/2	150
RFPFA-375-437	3/8	7/16	1/32	3-1/2	128
RFPFA-437-500	7/16	1/2	1/32	4	112
RFPFA-500-562	1/2	9/16	1/32	CF	CF

Heavy Wall Tubing Part Number

RFPFA-062-187	1/16	3/16	1/16	1/2	617
RFPFA-125-250	1/8	1/4	1/16	1/2	454
RFPFA-187-312	3/16	5/16	1/16	1	371
RFPFA-250-375	1/4	3/8	1/16	1	310
RFPFA-312-437	5/16	7/16	1/16	2	265
RFPFA-375-500	3/8	1/2	1/16	2	232
RFPFA-500-625	1/2	5/8	1/16	3	186
RFPFA-625-750	5/8	3/4	1/16	6	155
RFPFA-875-100	7/8	1	1/16	22	116
RFPFA-100-1125*	1	1-1/8	1/16	CF	105
RFPFA-1125-1250**	1-1/8	1-1/4	1/16	CF	84
RFPFA-1250-1375**	1-1/4	1-3/8	1/16	CF	CF

Special Size Tubing Part Number

RFPFA-170-250	.170	.250	.040	1	300
RFPFA-156-250	.156	.250	.047	3/4	352
RFPFA-100-110*	1	1.10	.050	CF	CF

Metric Size Tubing Part Number

RFPFA-2MM-4MM	2mm	4mm	1mm	1-1/2	468
RFPFA-3MM-5MM	3mm	5mm	1mm	CF	CF
RFPFA-4MM-6MM	4mm	6mm	1mm	1-3/4	312
RFPFA-5MM-7MM	5mm	7mm	1mm	CF	CF
RFPFA-6MM-8MM	6mm	8mm	1mm	2-1/2	234
RFPFA-6MM-9MM	6mm	9mm	1.5mm	CF	CF
RFPFA-7MM-9MM	7mm	9mm	1mm	CF	CF
RFPFA-8MM-10MM	8mm	10mm	1mm	2-3/4	187
RFPFA-9MM-11MM	9mm	11mm	1mm	CF	CF
RFPFA-10MM-12MM	10mm	12mm	1mm	4	156
RFPFA-11MM-13MM	11mm	13mm	1mm	CF	CF
RFPFA-12MM-14MM	12mm	14mm	1mm	CF	CF
RFPFA-14MM-16MM	14mm	16mm	1mm	CF	CF

CF = Consult Factory

* Only available in straight lengths OR reels

** Only available in straight lengths

FEP Tubing

FEP tubing is an economical choice for tubing applications requiring chemical resistance in combination with broad temperature exposure. FEP tubing and pipe offer excellent clarity which makes them ideal for sight glass and other flow monitoring applications. Additionally, the outstanding UV transmission rate of FEP makes the tubing a clear choice for UV water purification systems in straight lengths or coiled hose constructions.

Temperature

-100°F to 400°F

Features

- 100% virgin grade high performance resins used to resist stress cracking
- Chemically inert to most industrial chemicals and solvents
- High thermal stability
- Excellent UV transmission
- Low permeability
- Moisture absorption nearly zero
- FDA compliant for food contact
- Non-flammable
- Self extinguishing
- Superior electrical insulation properties
- FEP Tubing is also available in coiled hose, convoluted tubing, and heat-shrink constructions

Applications

- Chemical process
- Aquatic
- Laboratory
- UV water purification systems
- Ground water monitoring
- Ground remediation
- Food processing
- Electrical insulation
- Telecommunications
- Conduit
- Heat exchangers

Packaging

- Per customer's specifications
- Clean room packed
- Available pre-flared and pre-cut
- Sterilization
- Available DI washed and nitrogen packed

Certifications

- FEP tubing & pipe meet the requirements of USP Class VI Standards
- FEP tubing and pipe are approved for use in food contact applications in compliance with FDA 21 CFR 177.1550
- FEP tubing meets or exceeds the requirements listed in ASTM D3296-03

Standard Wall Tubing

Part Number	ID Inch	OD Inch	Wall Inch	Bend Radius Inch	Max WP @ 72°F psig
RFFEP-062-125	1/16	1/8	1/32	1/2	445
RFFEP-062-187	1/16	3/16	1/16	1/2	612
RFFEP-125-250	1/8	1/4	1/16	1/2	460
RFFEP-125-187	1/8	3/16	1/32	3/4	296
RFFEP-187-312	3/16	5.16	1/16	1	368
RFFEP-187-156	3/32	5.32	1/32	CF	CF
RFFEP-187-250	3/16	1/4	.030	1	223
RFFEP-250-312	1/4	5/16	.030	1-3/4	178
RFFEP-250-375	1/4	3/8	1/16	1	307
RFFEP-312-375	5/16	3/8	.030	2-1/2	148
RFFEP-375-437	3/8	7/16	.030	3-1/2	127
RFFEP-375-500	3/8	1/2	.062	2	230
RFFEP-437-500	7/16	1/2	.030	6	111
RFFEP-500-625	1/2	5/8	.062	3	184
RFFEP-625-750	5/8	3/4	1/16	6	153
RFFEP-875-1000*	7/8	1	.062	22	115
RFFEP-100-1125*	1	1-1/8	.062	CF	75
RFFEP-1125-1250**	1-1/8	1-1/4	1/16	CF	70

Metric Size Tubing

RFFEP-2MM-4MM	2mm	4mm	1mm	1-1/2	464
RFFEP-3MM-5MM	3mm	5mm	1mm	CF	CF
RFFEP-4MM-6MM	4mm	6mm	1mm	1-3/4	309
RFFEP-5MM-7MM	5mm	7mm	1mm	CF	CF
RFFEP-6MM-8MM	6mm	8mm	1mm	2-1/2	232
RFFEP-7MM-9MM	7mm	9mm	1mm	CF	CF
RFFEP-8MM-10MM	8mm	10mm	1mm	2-3/4	186
RFFEP-9MM-11MM	9mm	11mm	1mm	CF	CF
RFFEP-10MM-12MM	10mm	12mm	1mm	4	155
RFFEP-11MM-13MM	11mm	13mm	1mm	CF	CF
RFFEP-12MM-14MM	12mm	14mm	1mm	CF	CF

CF = Consult Factory

* Only available in straight lengths OR reels

** Only available in straight lengths

PTFE Tubing

PTFE tubing is the most flexible of all fluoropolymer tubing offered. It has the broadest temperature range of any fluoropolymer and can resist highly corrosive liquids and gases even at elevated temperatures.

Temperature

-410°F to 500°F

Features

- 100% virgin grade PTFE resins
- Most flexible fluoropolymer tubing as compared with: FEP, PFA, HP PFA, UHP PFA, ETFE, ECTFE
- Chemically inert and resistant to nearly all industrial chemicals and solvents
- Low permeability
- Smooth non-stick surface finish
- Lowest coefficient of friction
- Excellent electrical properties
- Non-flammable
- Non-toxic
- FDA compliant

Applications

- Laboratory
- Chemical process
- Emissions monitoring
- Ozone
- Analytical and process equipment
- Cryogenic
- High temperature
- Electrical

Packaging

- Continuous coils or pre-cut lengths
- Clean room packaging

Certifications

- FDA 21 CFR 177.1550

Standard Wall Tubing

Part Number	ID Inch	OD Inch	Wall Inch	Bend Radius Inch	Max WP @ 72°F psig
RFPTFE-062-125	1/16	1/8	1/32	1/2	300
RFPTFE-125-250	1/8	1/4	1/16	1/2	310
RFPTFE-125-187	1/8	3/16	1/32	3/4	200
RFPTFE-156-250	5/32	1/4	.040	1	200
RFPTFE-170-250	.170	.250	.040	1	200
RFPTFE-187-312	3/16	5/16	1/16	CF	CF
RFPTFE-187-250	3/16	1/4	.030	1	150
RFPTFE-250-312	1/4	5/16	.030	1-3/4	257
RFPTFE-250-375	1/4	3/8	1/16	3/4	207
RFPTFE-312-375	5/16	3/8	1/32	CF	CF
RFPTFE-375-500	3/8	1/2	1/16	2-1/2	155
RFPTFE-437-500	7/16	1/2	1/32	6	75

Metric Size Tubing

Part Number	ID mm	OD mm	Wall mm	Bend Radius mm	Max WP @ 72°F psig
RFPTFE-2MM-4MM	2mm	4mm	1mm	CF	CF
RFPTFE-4MM-6MM	4mm	6mm	1mm	1	208
RFPTFE-6MM-8MM	6mm	8mm	1mm	1.5	156
RFPTFE-8MM-10MM	8mm	10mm	1mm	2	125
RFPTFE-10MM-12MM	10mm	12mm	1mm	4	104

PTFE tubing is suitable for use with conventional fittings. CF = Consult Factory

RFSC Silicone Tubing

Platinum-cured silicone tubing is clean-room produced for critical pharmaceutical, biomedical, cosmetic, and food applications.

Temperature

-100°F to 400°F

Features

- Extremely flexible
- Will not impart taste or odor
- Non-pyrogenic
- Lot and batch traceable
- Ultra pure medical grade
- Resists temperature extremes, chemical attack, ozone, radiation, and moisture

Applications

- Bio process equipment
- USP water
- Hot WFI
- Sterile transfer
- Cell culture media
- Aseptic fill & transfer

Certifications

- USP Class VI
- FDA CFR 177-2600
- Meets 3-A Sanitary Standards
- CGMP (Current Good Manufacturing Practices)
- Cytotoxicity Criteria
- ADI Free®

Part Number	ID Inch	OD Inch	Wall Inch	Part Number	ID Inch	OD Inch	Wall Inch
02RFSC2	.125	.250	.063	06RFSC3	.375	.563	.094
02RFSC3	.125	.313	.094	06RFSC4	.375	.625	.125
03RFSC2	.188	.313	.063	08RFSC3	.500	.688	.094
03RFSC3	.188	.375	.094	08RFSC4	.500	.750	.125
03RFSC4	.188	.438	.125	09RFSC3	.563	.750	.094
04RFSC2	.250	.375	.063	10RFSC4	.625	.875	.125
04RFSC3	.250	.438	.094	10RFSC5	.625	1.00	.188
04RFSC4	.250	.500	.125	12RFSC4	.750	1.00	.125
05RFSC2	.313	.438	.063	14RFSC2	.875	1.00	.063
05RFSC3	.313	.500	.094	16RFSC4	1.00	1.25	.125
06RFSC2	.375	.500	.063	16RFSC5	1.00	1.375	.188

Available: bulk, spools, and molded, reusable, and crimped end connections



PVDF (Kynar®)

PVDF (Kynar-Flex®) is an abrasion resistant fluoropolymer acceptable for use in applications requiring chemical resistance with low permeability. PVDF has excellent chemical resistance, is UV, ozone, and abrasion resistant.

Temperature

-20°F to 212°F

Features

- Strength and toughness
- Weather resistant
- UV resistant
- Radiation resistant
- High thermal stability
- Fungus resistant
- Ozone resistant

Applications

- Food and beverage
- Bags
- Battery binders and separators
- Fabricated vessels
- Filters
- Multi-layered pipe
- Pumps
- Tanks
- Tubing
- Valves
- Vessels

Certification

- Meets USP Class VI Standards
- Kynar-Flex® is approved for use in food contact applications in compliance with FDA 21 CFR 177.2600
- NSF-51 and 61

Kynar® and Kynar-Flex® is a registered trademark of Alkema

Standard Wall Tubing

Part Number	ID Inch	OD Inch	Wall Inch	Bend Radius Inch	Max WP @ 72°F psig	Vacuum Rating @ 72°F in. Hg.	Weight Per 50 Foot Coil
RFPVDF-125-187	1/8	3/16	1/32	3/4	168	29.9	0.59
RFPVDF-187-250	3/16	1/4	1/32	1	126	29.9	0.84
RFPVDF-250-312	1/4	5/16	1/32	1-3/4	101	29.9	1.06
RFPVDF-312-375	5/16	3/8	1/32	2-1/2	84	29.9	1.32

Custom Size Tubing

RFPVDF-170-250	.170	.250	.040	1	155	29.9	1.02
RFPVDF-156-250	5/32	1/4	.047	3/4	177	29.9	1.16

Heavy Wall Tubing

RFPVDF-125-250	1/8	1/4	1/16	1/2	260	29.9	1.43
RFPVDF-250-375	1/4	3/8	1/16	1	174	29.9	2.38
RFPVDF-375-500	3/8	1/2	1/16	2	130	29.9	3.33

Metric Size Tubing

RFPVDF-2MM-4MM	2mm	4mm	1mm	CF	CF	29.9	0.57
RFPVDF-4MM-6MM	4mm	6mm	1mm	CF	CF	29.9	0.94
RFPVDF-6MM-8MM	6mm	8mm	1mm	CF	CF	29.9	1.32
RFPVDF-8MM-10MM	8mm	10mm	1mm	CF	CF	29.9	1.70
RFPVDF-10MM-12MM	10mm	12mm	1mm	CF	CF	29.9	2.08

CF = Consult Factory

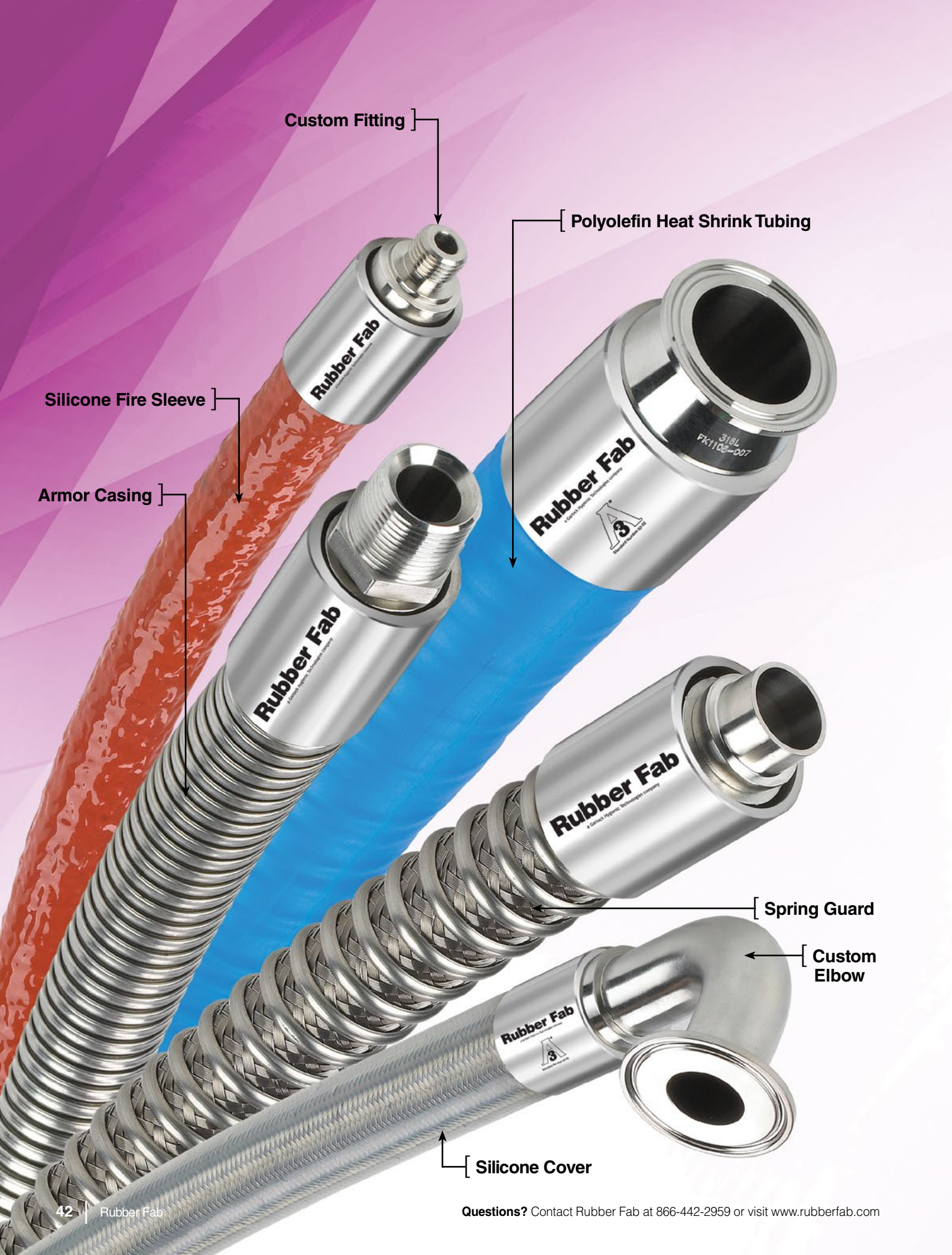

Custom Fitting

Polyolefin Heat Shrink Tubing

Silicone Fire Sleeve

Armor Casing

Spring Guard

Custom Elbow

Silicone Cover

Accessories

Rubber Fab offers the following accessories and hose enhancements to meet specific needs during certain operations. Other hose covers and accessories are available.

Armor Casing



Armor Casing is a highly flexible, heavy duty metal casing which protects the hose against rough handling and over bending. Armor can be applied over the entire length of the hose or as an armor cuff. Armor cuffs can be applied in 12"-18" lengths to each end of the hose to prevent kinking and hose stress.

Silicone Fire Sleeve



TEMPERATURE:

Continuous: -65°F to 500°F

Intermittent: -65°F to 2000°F

TESTED IN ACCORDANCE WITH:

UL-73, NFPA-250, ASTM-E84

Silicone Fire Sleeve has a coating of specially compounded silicone rubber bonded to a low-density high bulk fiberglass sleeve. This unique combination offers a temporary barrier to flame penetration and provides long term mechanical/environmental protection. Applications include steel manufacturing plants, foundries, glass factories, and welding/cutting shops.

Silicone Cover



A clear silicone cover provides protection during extreme environmental exposure. Provides ease of cleanability when over a braided stainless steel hose. Cover also serves as a "to the touch" thermal insulator.

Polyolefin Heat Shrink Tubing



TEMPERATURE: -65°F to 275°F

Polyolefin Heat Shrink Tubing provides easy cleaning of the outer hose surface and is extremely beneficial in applications where cleanliness is essential, such as food and pharmaceutical processes.

Polyolefin Heat Shrink Tubing also provides coloring for product line identification and is available in clear, brown, black, white, red, yellow, green, and blue.

Spring Guard



Spring Guard is used to prolong the life of hose lines exposed to rugged operating conditions, such as severe flexing. Spring Guard prevents kinking and protects against abrasion.

Stainless Steel Braid



304 Stainless Steel braided sleeving provides protection against temperature and abrasion. Available to go over 1/2"-4" hose.

Golden Bridge

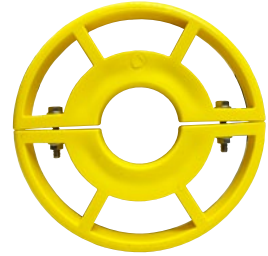

The Golden Bridge is a heavy duty, safety yellow, hose support that easily bolts together over any hose or stainless steel piping system. A series of bridges elevate the hose or pipe off the floor keeping the hose clean, reducing wear and tear on the cover, and preventing damage to the sanitary end connections. See page 44 for more information.

Vibration Isolator



Rubber Fab's flexible silicone joints, installed between pumps (or other sources of vibration) and fixed sanitary pipelines, absorb vibration that can weaken or damage critical pipeline systems, and because they are flexible, slight misalignment of connections is not a problem. See rubberfab.com for more information.



Rubber Fab's Golden Bridge Hose Support

Rubber Fab's new and improved Golden Bridge hose support system has a new two piece design made with an impact and abrasion resistant thermo plastic, making it lightweight, yet strong as ever.

The Golden Bridge is a heavy duty, safety yellow, hose support that easily bolts together over any hose or stainless steel piping system. A series of bridges elevate the hose or pipe off the floor keeping it clean, reducing wear and tear on the cover, and preventing damage to the sanitary end connections. And when it's time for wash down, the Golden Bridge prevents damming allowing C.I.P. solutions and wash water to reach the floor drain. A benefit that helps prevent bacterial growth on the hose.

The Rubber Fab Golden Bridge provides safety features that are a must in any active production facility. The open-face "handle" design is

easy to grab for hose positioning and the safety yellow coating is not only easy to clean, it's hard to miss!

FEATURES

- Safety yellow for high visibility
- Easy installation - new two piece design
- Supports and elevates hose and sanitary stainless steel piping systems
- Eliminates hose abrasion
- Protects hose fittings from damage
- Open face design eliminates bacterial entrapment during wash down allowing wash fluids to reach floor drain
- Raised design lifts hose and stainless steel piping off floor stopping damming and preventing bacterial growth
- Easy grip handle aides in hose and ss pipe movement, placement and handling
- Protects floor from damage

MATERIAL AVAILABLE

- High Impact/Abrasion Resistant HDPE Thermo Plastic

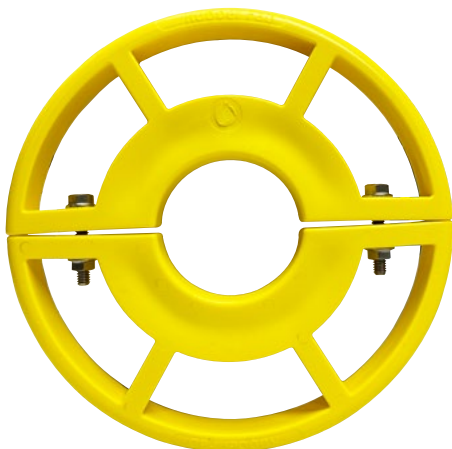

Part Number	Hose Size Inch	Size Inch	Assembled Weight lbs
GOLDENBRIDGE-8-16-NM	1.35 to 1.60 OD	8	1.00
GOLDENBRIDGE-8-24-NM	1.97 to 2.20 OD	8	1.00
GOLDENBRIDGE-8-32-NM	2.48 to 2.70 OD	8	1.00
GOLDENBRIDGE-10-40-NM	3.10 to 3.30 OD	10	1.35
GOLDENBRIDGE-10-48-NM	3.52 to 3.90 OD	10	1.35
GOLDENBRIDGE-10-64-NM	4.60 to 4.90 OD	10	1.35

Note:

Please consult factory for additional sizes. Minimums may apply.

Selection, Design and Installation Notes: STAMPED

Selection of the proper hose assembly for any given application should take into account the following seven considerations. They are known by the acronym STAMPED.

S SIZE

Hose inside diameter, outside diameter and overall length.

T TEMPERATURE

Maximum temperature of the material being conveyed and of the application environment

A APPLICATION

External conditions/environment such as abrasion, bend radius, climate/temperature, crushing, flexing, kinking, and exposure to chemicals, oil, ozone, and ultraviolet light.

M MEDIA

Type and concentration of material being conveyed and compatibility with the hose

P PRESSURE

Maximum system pressure, including pressure spikes.

E ENDS

Style, type, attachment method, pressure rating, and material compatibility of end couplings and connections.

D DELIVERY

Testing, packaging, and delivery requirements.

Other Considerations: Abrasion, color, conductivity/nonconductivity, suction/vacuum; industry or regulatory specifications or standards.



How To Build A Hose Assembly

Ordering Rubber Fab Hose Assemblies and understanding a Rubber Fab Part Number

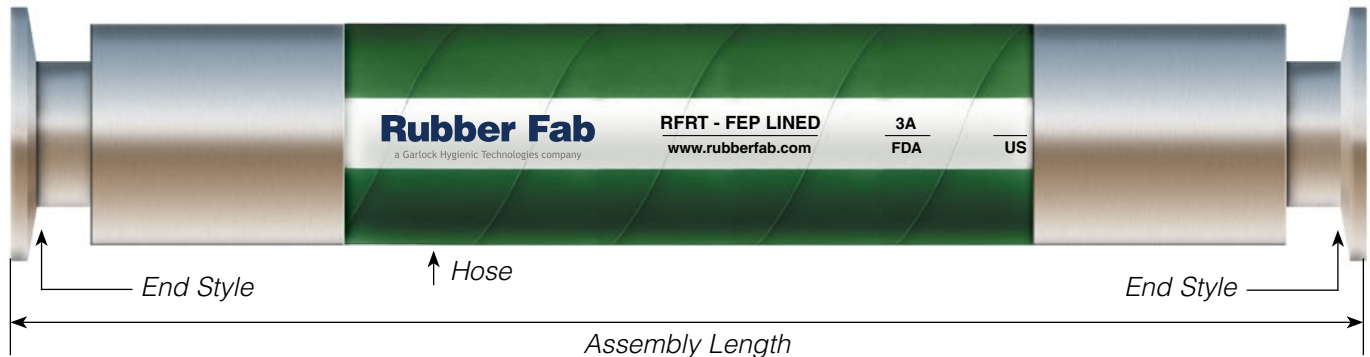

Example part#:

16RFRT16TC16TCSSAR-36

When you break it down, what does this part# mean?

16 RFRT 16TC 16TC SS AR - 36

16 **Hose ID – Size in 16th of an Inch**
ID for this hose is 1 inch

RFRT **Rubber Fab Hose Type**
This hose is RFRT – Smoothbore FEP Lined EPDM Rubber Hose

16TC 16TC **Size and Style of Fitting Ends**
Both fittings on this hose are 1 inch Sanitary Tri-Clamp®

SS **Fitting Material**
The fittings for this hose are 316L Stainless Steel

AR **Accessory** (not pictured in example)
This armor casing accessory will cover the length of live hose

-36 **Overall Assembly Length in Inches**
The overall length of this hose is 36 inches

Ordering Hose Assemblies

Hose I.D. In 16th of inch

02	=	.125"
04	=	.25"
06	=	.375"
08	=	.50"
12	=	.75"
16	=	1.00"
20	=	1.25"
24	=	1.50"
32	=	2.00"
40	=	2.50"
48	=	3.00"
64	=	4.00"
96	=	6.00"
128	=	8.00"

Rubber Fab Hose Type

FDA Rubber Hose

RFFDAEOC
RFFDAE
RFFDAELF
RFF&B
RFFDA
RFFDAOC
RFFDAC
RFFDABOC

Washdown Hose

RFDWAM

Smoothbore

RFRTPOC
RFRT
RFRTTP
RFRTPW
RFST
RFSTFT
RFSTS
RFSTB
RFSTBS
RFSF
RFTFP

Convuluted Fluoropolymer

RFCTLP
RFCTLPFT
RFCTLPS
RFCTLPB
RFCTLPP
RFCTLPPFT
RFCTLPPB

Metal Hose

RFSSH
RFSSHT

Sight Glass

RFSG
RFCSG
RFPSSG
RFBSG

Metal Detection Tube

RFKMD

Silicone

RFSB
RFSBX
RFSBHP
RFS4P
RFSV
RFSVOC

FDA PVC Hose

RFPB
RFPVV
RFPVW
RFPC

Size and Style of Fitting Ends

BB	=	Hose Barb X Hose Barb
BSN	=	Bevel Seat Nut
BWP	=	Buttweld Pipe
BWT	=	Buttweld Tube
CTA	=	Compression Tube Adapter
CTAFN	=	Compression Tube Adapter Ferrule and Nut
CTC	=	Compression Tube Connector
CTCFN	=	Compression Tube Connector Ferrule and Nut
FCL	=	Female Camlock
FIL	=	Female I-Line
FJIC	=	Female JIC w/nut
FPT	=	Female Pipe Thread
FUA	=	Female Union Adapter
JPF	=	John Perry Female
JPM	=	John Perry Male
LJF	=	Lap Joint Flange
MBS	=	Male Bevel Seat

MCL	=	Male Camlock
MIL	=	Male I-Line
MPT	=	Male Pipe Thread
MTC	=	Maxi Tri-Clamp®
MUA	=	Male Union Adapter
QL	=	Q-Line
RTC	=	Reuseable Tri-Clamp®
SL	=	Sani-Lock®
SSTEF	=	PTFE Encapsulated
TC	=	Sanitary Tri-Clamp® & Mini Tri-Clamp®
TC45	=	45° TC Elbow
TC90	=	90° TC Elbow

Fitting Material

4	=	304SS Material or 304SS 150# Flanges
6	=	316SS Material or 316SS 150# Flanges
AL	=	Aluminum
BR	=	Brass
CS	=	Carbon Steel
FL	=	Flare Thru
HC22	=	Hastelloy C22
HC276	=	Hastelloy C276
K	=	Kynar® (PVDF)
M	=	Molded Ends
MO	=	Monel
PP	=	Polypropylene
PS	=	Polysulfone
PVC	=	PVC
SS	=	316L Stainless Steel
SSEP	=	316L Stainless Steel, Electropolished

Accessory

AC	=	Armor Cuff
AR	=	Armor
D	=	Donut
FS	=	Fire Sleeve
GB	=	Golden Bridge
GR	=	Grounded
PO	=	Polyolifin Shrink Wrap
SB	=	Stainless Braid
SG	=	Spring Guard
SL	=	Silicone Cover
TSW	=	PTFE/FEP Shrink Wrap

Bend Radius

Flexibility and minimum bend radius are important factors in hose design and selection if it is known that the hose will be subjected to sharp curvatures in normal use. When bent at too sharp of an angle, the hose may kink or flatten in the cross-section. The reinforcement may also be unduly stressed or distorted and the hose life thereby shortened.

Adequate flexibility means the hose should be able to conform to the smallest anticipated bend radius without over stress. The minimum bend radius is generally specified for each hose in this catalog. This is the radius to which the hose can be bent in service without damage or appreciably shortening its life. The radius is measured to the inside of the curvature.

BEND RADIUS:

For fluoropolymer hose and all rubber hose the radius of a bent section of hose measured to the innermost surface of the curved portion (R1).

For metal hose the radius of a bent section of hose measured to the hose centerline (R2).

MINIMUM BEND RADIUS:

The smallest radius at which a hose can be used.

FORCE TO BEND:

The amount of stress required to induce bending around a specified radius—a measurement of stiffness.

MAXIMUM RATED WORKING PRESSURE:

The maximum pressure hoses should be subjected to on a continuous basis.

MAXIMUM RATED TEST PRESSURE:

The maximum rated pressure is multiplied by 150%.

NOMINAL RATED BURST PRESSURE:

The average pressure at which the core or braid will rupture at ambient temperature.

PRESSURE/TEMPERATURE CORRECTION:

Hose pressure capabilities decrease as the temperature increases. Consult factory to determine pressure rating at elevated temperatures.

BEND RADIUS FORMULA:

Formula to determine minimum hose length given bend radius and degree of bend required.

$$L = \frac{A}{360^\circ} \times 2\pi B$$

L = Minimum length of hose to make bend (bend must be made equal along this portion of hose length).

A = Angle of bend

B = Given bend radius of hose

π = 3.14

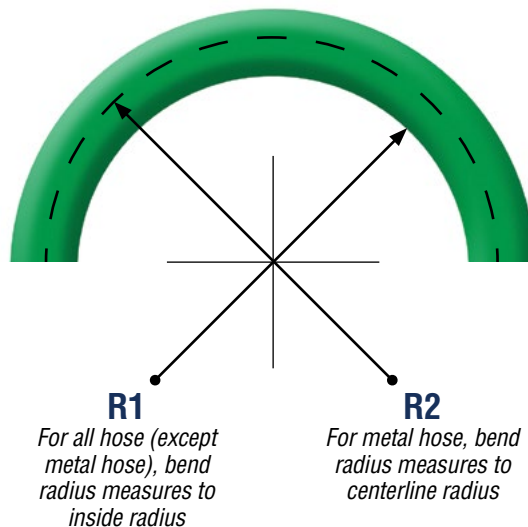

Tolerances

The overall length tolerance for hose assemblies are:

+/- 1/4" on assemblies 6 to 24 inches overall length.

+/- 1/2" on assemblies 24 to 60 inches overall length.

Not to exceed +/- 1% on assemblies over 60 inches overall length.

Measuring Hose Assemblies

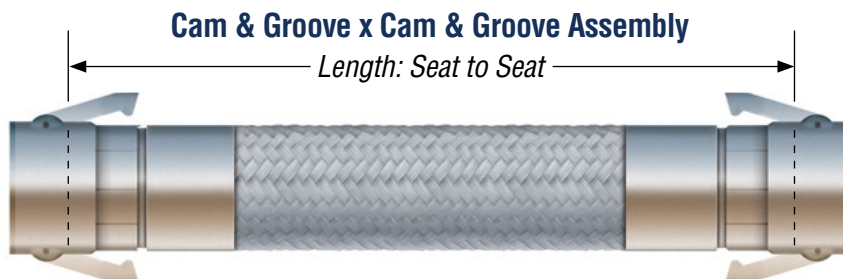
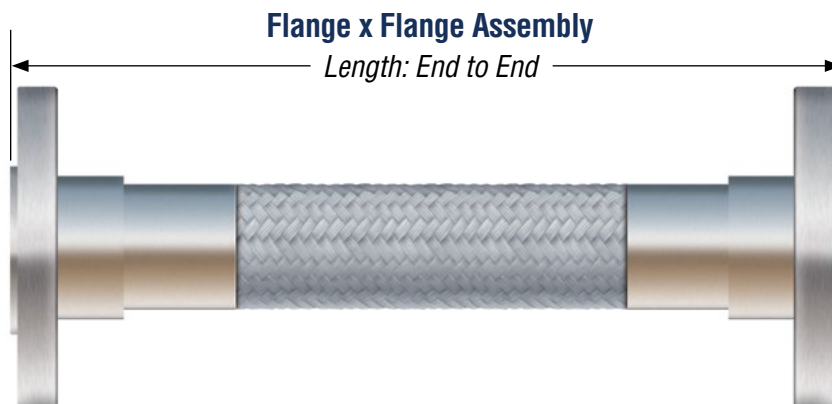
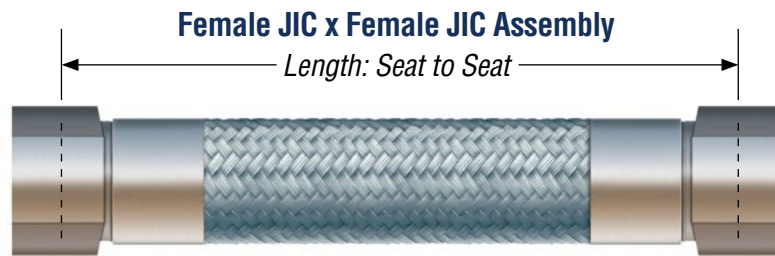
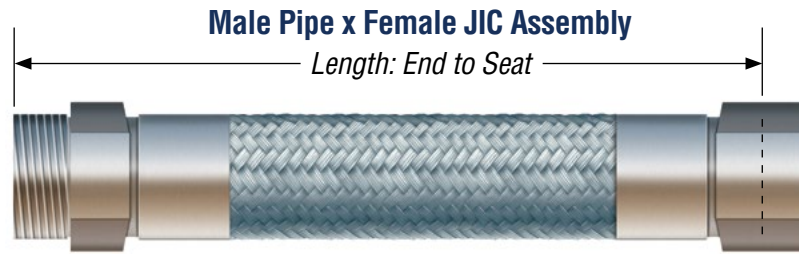

Tri-Clamp® Sizing Guide

These actual size drawings are provided to eliminate sizing errors when specifying sanitary fittings. The outside diameter is the same for 1/8", 1/4", 3/8", 1/2", and 3/4" ID, "mini" sizes (0.992" OD). The same holds true for the 1" and 1-1/2" ID sizes (1.984" OD).

The 2", 2-1/2", 3", 4", and 6" ID have specific OD diameters.

For your convenience and ordering accuracy, all of these drawings may be used as sizing ID and OD patterns.

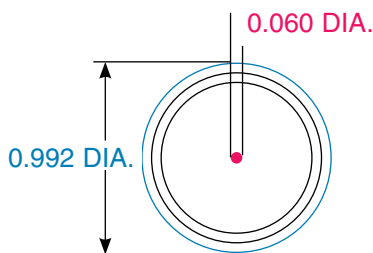

1/8" MINI TC

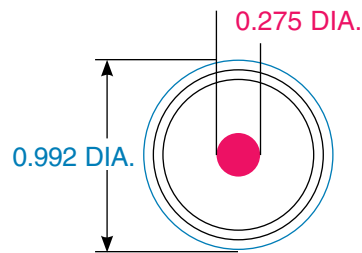

3/8" MINI TC

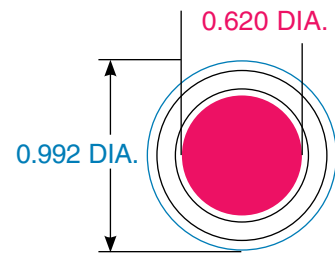

3/4" MINI TC

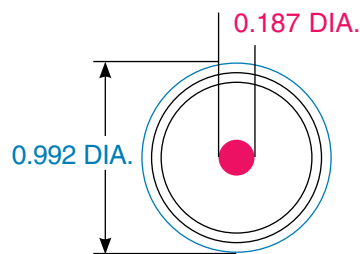

1/4" MINI TC

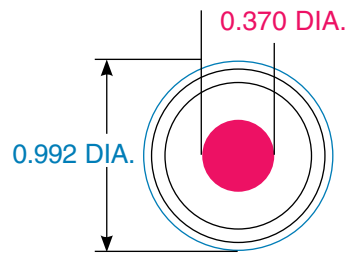

1/2" MINI TC

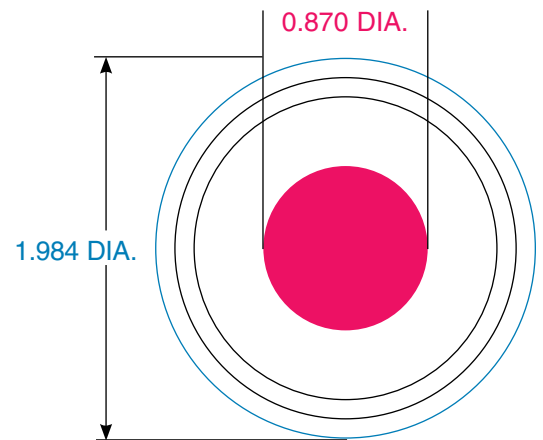

1" LADISH® TC

NOTE:

ID measurements are indicated in red
OD measurements are indicated in blue

Tri-Clamp® Sizing Guide

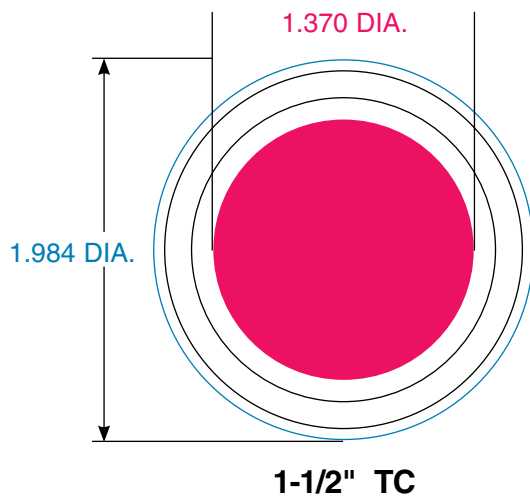
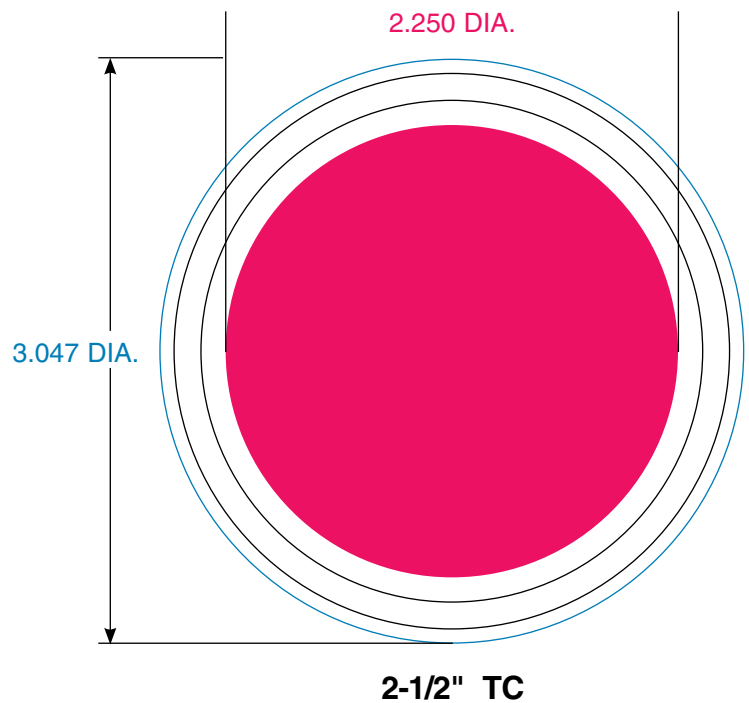
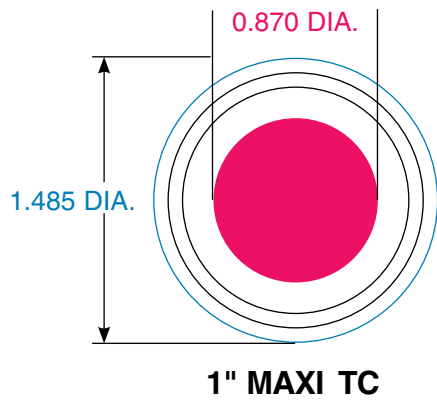
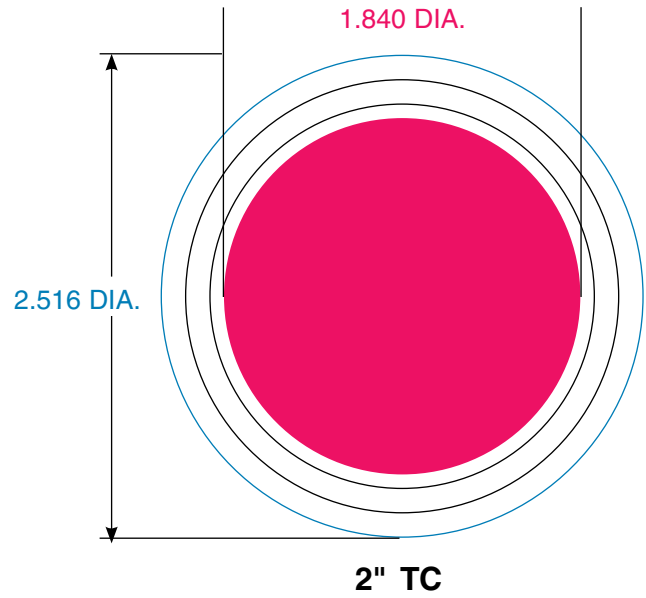
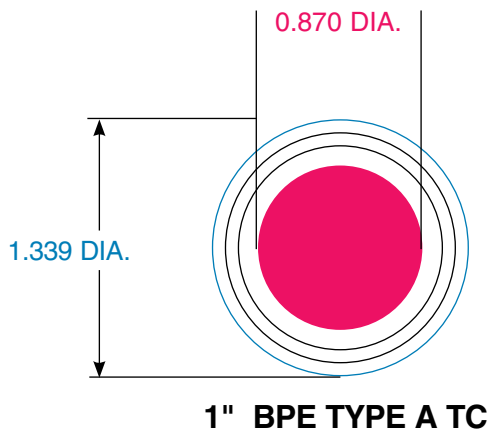

Tri-Clamp® Sizing Guide

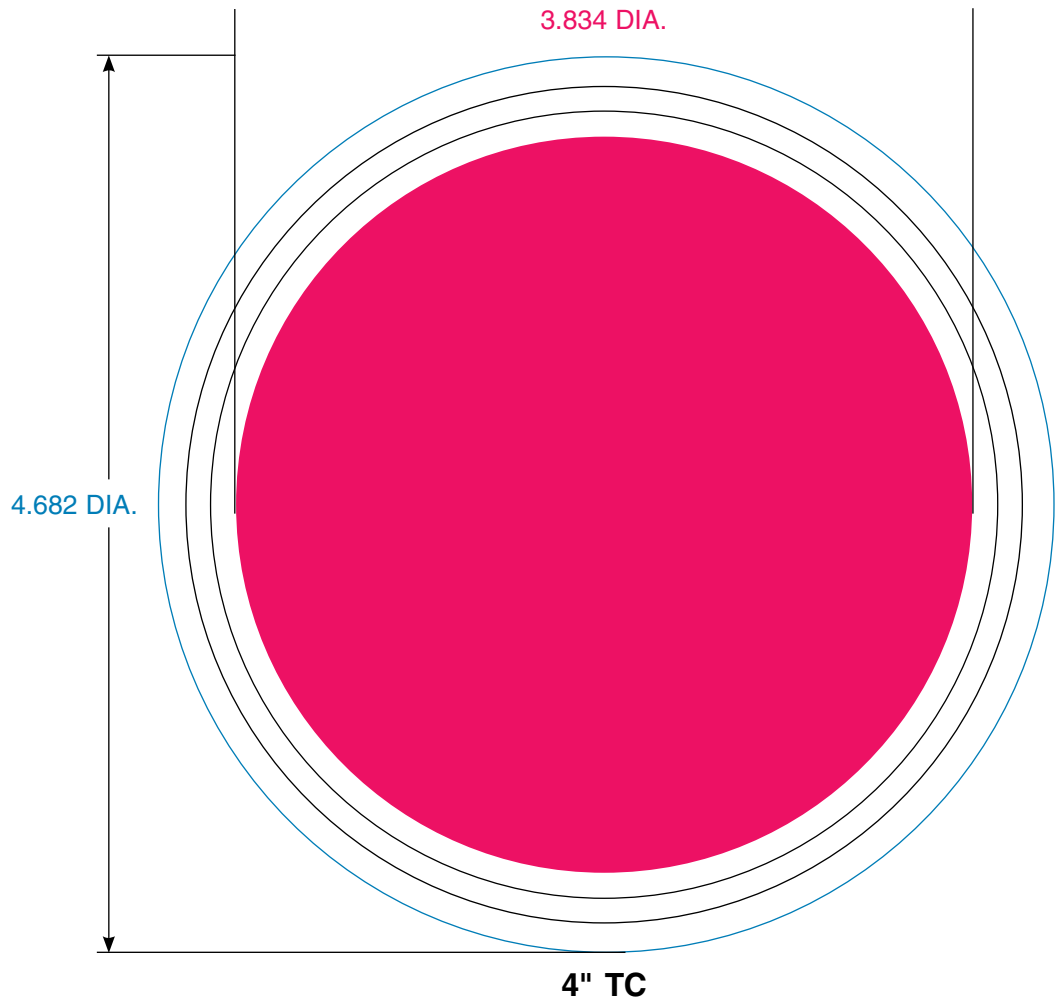
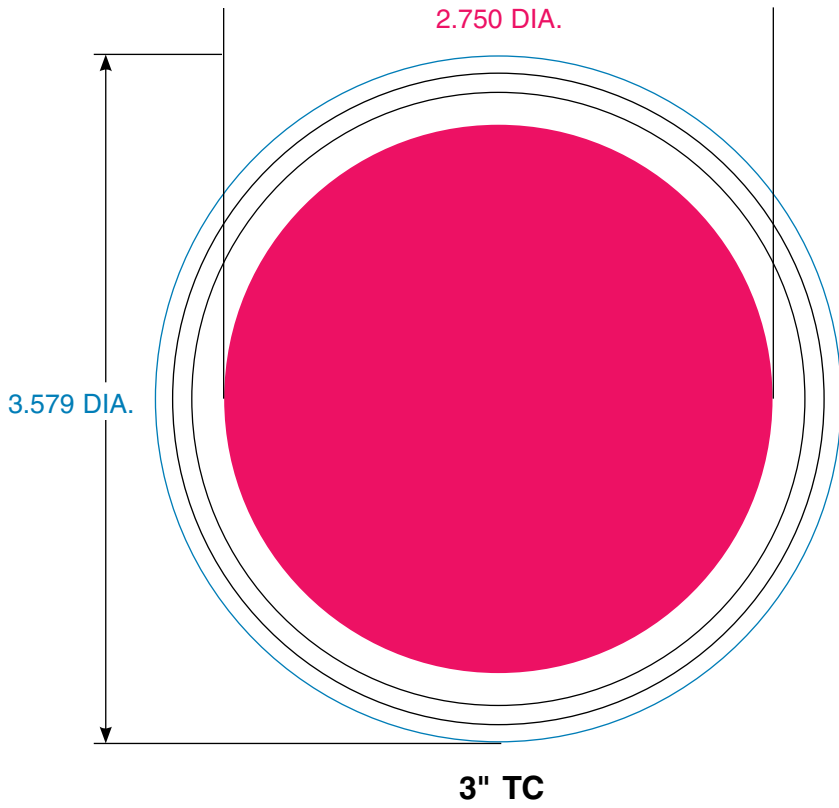

Tri-Clamp® Sizing Guide

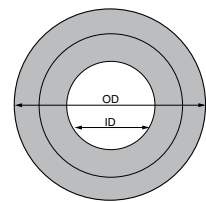
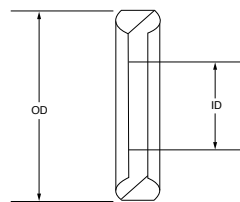
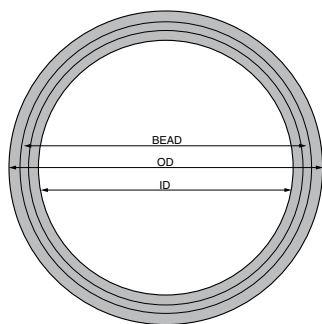
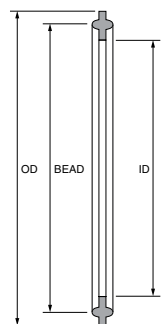
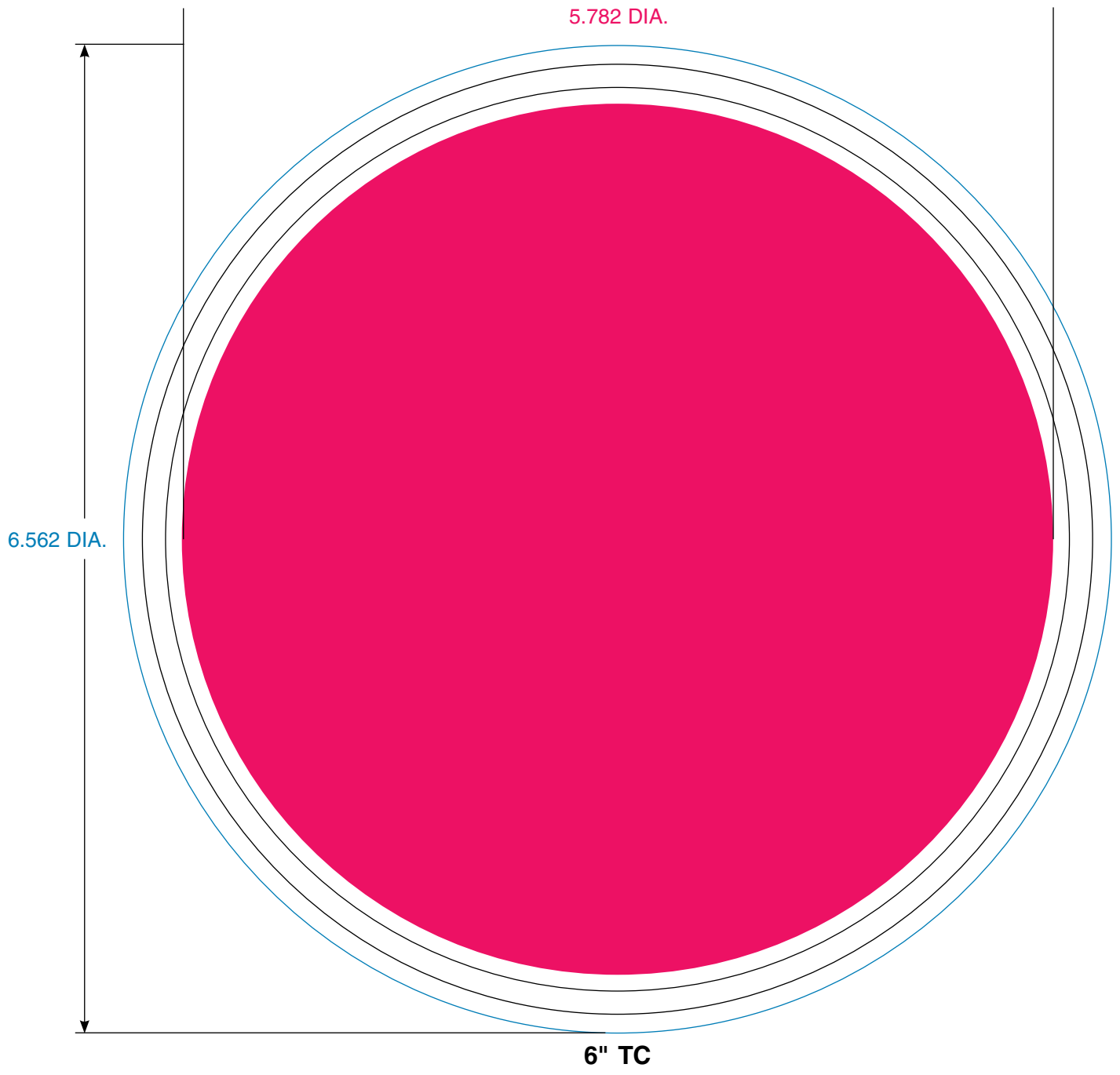

Dimensional Chart for Tri-Clamp® Gaskets

ID		OD		Bead		Series A DIN32676	Series B ISO1127	Series C ASME BPE	ISO 2852	SMS 3019	BS 4825-3	SCH 5 BS	Special Size
inch	mm	inch	mm	inch	mm								
0.17	4.20	0.86	21.80	0.80	20.20								X
0.19	4.80	0.86	21.80	0.80	20.20			1/4"					
0.24	6.20	0.86	21.80	0.80	20.20	DN06							
0.28	7.20	0.86	21.80	0.80	20.20		DN06						
0.31	8.00	0.86	21.80	0.80	20.20			3/8"					
0.32	8.20	0.86	21.80	0.80	20.20	DN08							
0.38	9.60	0.86	21.80	0.80	20.20			1/2"			1/2"		
0.41	10.50	0.86	21.80	0.80	20.20		DN08						
0.48	12.20	0.86	21.80	0.80	20.20								X
0.56	14.20	0.86	21.80	0.80	20.20		DN10						
0.63	16.00	0.86	21.80	0.80	20.20			3/4"			3/4"		
0.88	22.30	1.34	34.00	0.80	20.20			1" Type A					
* 21.8mm gaskets do not have a ferrule bead (Including 1" Type A). 21.8mm sizes utilize size: 13MHHM-304-050/075													
0.39	10.00	1.34	34.00	1.08	27.50					DN12			
0.40	10.20	1.34	34.00	1.08	27.50	DN10			DN12				
0.41	10.50	1.34	34.00	1.08	27.50								X
0.43	10.90	1.34	34.00	1.08	27.50			DN12.7					
0.56	14.20	1.34	34.00	1.08	27.50								X
0.61	15.40	1.34	34.00	1.08	27.50			DN17.2					
0.64	16.20	1.34	34.00	1.08	27.50	DN15				DN18			
0.72	18.30	1.34	34.00	1.08	27.50								X
0.77	19.50	1.34	34.00	1.08	27.50			DN21.3					
0.80	20.20	1.34	34.00	1.08	27.50	DN20							
0.88	22.30	1.34	34.00	1.08	27.50								X
Above sizes utilize clamp size: 13MHHM-304-34mm (Including 1" Type A)													
0.40	10.20	2.00	50.50	1.71	43.50								X
0.56	14.20	2.00	50.50	1.71	43.50								X
0.64	16.20	2.00	50.50	1.71	43.50								X
0.72	18.30	2.00	50.50	1.71	43.50		DN15						
0.80	20.20	2.00	50.50	1.71	43.50								X
0.88	22.30	2.00	50.50	1.71	43.50			1"					
0.90	22.80	2.00	50.50	1.71	43.50				DN25	DN25			
0.90	22.90	1.49	37.70	1.25	31.75								X
0.94	23.90	2.00	50.50	1.71	43.50		DN20						
1.03	26.20	2.00	50.50	1.71	43.50	DN25							
1.18	29.90	2.00	50.50	1.71	43.50		DN25						
1.20	30.50	2.00	50.50	1.71	43.50							1"	
1.24	31.50	2.00	50.50	1.71	43.50				DN33.7	DN33.7			
1.27	32.50	2.00	50.50	1.71	43.50	DN32							
1.38	35.00	2.00	50.50	1.71	43.50			1.5"			1.5"		
1.41	35.80	2.00	50.50	1.71	43.50				DN38	DN38			
1.50	38.20	2.00	50.50	1.71	43.50	DN40							
1.52	38.60	2.00	50.50	1.71	43.50								X
Above sizes utilize clamp size: 13MHHM-304-100/150													
1.49	37.80	2.52	64.00	2.22	56.50				DN40				
1.52	38.60	2.52	64.00	2.22	56.50		DN32						
1.75	44.50	2.52	64.00	2.22	56.50		DN40						
1.78	45.30	2.52	64.00	2.22	56.50							1.5"	
1.88	47.70	2.52	64.00	2.22	56.50			2"			2"		
1.92	48.80	2.52	64.00	2.22	56.50				DN51	DN51			
1.98	50.20	2.52	64.00	2.22	56.50	DN50							
Above sizes utilize clamp size: 13MHHM-304-200													

ID		OD		Bead		Series A DIN32676	Series B ISO1127	Series C ASME BPE	ISO 2852	SMS 3019	BS 4825-3	SCH 5 BS	Special Size
inch	mm	inch	mm	inch	mm								
2.22	56.50	3.05	77.50	2.78	70.50		DN50						
2.26	57.40	3.05	77.50	2.78	70.50							2"	
2.38	60.40	3.05	77.50	2.78	70.50			2.5"			2.5"		
2.38	60.50	3.05	77.50	2.78	70.50				DN63.5	DN63.5			
Above sizes utilize clamp size: 13MHHM-304-250													
2.61	66.20	3.58	91.00	3.29	83.50	DN65							
2.64	67.00	3.58	91.00	3.29	83.50				DN70				
2.72	69.00	3.58	91.00	3.29	83.50							2.5"	
2.85	72.30	3.58	91.00	3.29	83.50		DN65						
2.88	73.10	3.58	91.00	3.29	83.50			3"	DN76.1	DN76.1	3"		
Above sizes utilize clamp size: 13MHHM-304-300													
3.20	81.20	4.17	106.00	3.82	97.00	DN80							
3.33	84.50	4.17	106.00	3.82	97.00		DN80						
3.35	85.10	4.17	106.00	3.82	97.00				DN88.9	DN88.9		3"	
Above sizes utilize clamp size: 13MHHM-V-304-300													
3.84	97.60	4.67	119.00	4.33	110.00			4"			4"		
3.85	97.80	4.67	119.00	4.33	110.00				DN101.6	DN101.6			
3.94	100.20	4.67	119.00	4.33	110.00	DN100							
Above sizes utilize clamp size: 13MHHM-304-400													
4.33	109.90	5.12	130.00	4.80	122.00		DN100						
4.35	110.50	5.12	130.00	4.80	122.00				DN114.3	DN114.3		4"	
Above sizes utilize clamp size: 13MHHM-V-304-400													
4.86	123.50	5.68	144.20	5.29	134.30			5**					
Above sizes utilize clamp size: 13MHHM-304-500													
4.93	125.20	6.10	155.00	5.75	146.00	DN125							
5.30	134.70	6.10	155.00	5.75	146.00		DN125						
5.35	135.90	6.10	155.00	5.75	146.00				DN139.7	DN139.7		5**	
Above sizes utilize clamp size: 13MHHM-V-304-500													
5.79	147.10	6.57	167.00	6.16	156.50			6"					
Above sizes utilize clamp size: 13MHHM-304-600													
5.91	150.20	7.20	183.00	6.85	174.00	DN150							
6.43	163.30	7.20	183.00	6.85	174.00		DN150		DN168.3	DN168.3		6"	
Above sizes utilize clamp size: 13MHHM-V-304-600													
7.78	197.60	8.56	217.40	8.15	207.00			8**					
Above sizes utilize clamp size: 13MHHM-304-800													
7.88	200.20	9.19	233.50	8.86	225.00	DN200							
8.43	214.10	9.19	233.50	8.86	225.00		DN200		DN219.1	DN219.1		8"	
Above sizes utilize clamp size: 13MHHM-V-304-800													
9.77	248.20	10.66	271.00	10.14	257.60	DN250*		10**					
Above sizes utilize clamp size: 13MHHM-304-1000													
10.49	266.50	11.32	287.60	11.00	279.40							10"	
Above sizes utilize clamp size: 13MHHM-V-304-1000													
11.81	300.00	12.56	319.00	12.17	309.00	DN300*		12**					
Above sizes utilize clamp size: 13MHHM-304-1200													
12.44	316.00	13.31	338.10	12.93	328.42							12"	
Above sizes utilize clamp size: 13MHHM-V-304-1200													

* Not included in the sanitary standard

Steam Table Guide

Gauge psi	Temp °F	Gauge psi	Temp °F	Gauge psi	Temp °F	Gauge psi	Temp °F	Gauge psi	Temp °F
5	227	45	293	85	328	150	366	230	399
6	230	46	294	86	328	152	367	232	400
7	232	47	295	87	329	154	368	324	400
8	235	48	296	88	330	156	369	235	401
9	237	49	297	89	331	158	370	237	402
10	240	50	298	90	331	160	371	239	402
11	242	51	299	91	332	162	372	241	403
12	244	52	300	92	333	164	372	243	404
13	246	53	301	93	333	166	373	245	404
14	248	54	302	94	334	168	374	247	405
15	250	55	303	95	335	170	375	249	406
16	252	56	304	96	335	172	376	251	406
17	254	57	305	97	336	174	377	253	407
18	255	58	306	98	337	176	378	255	408
19	257	59	306	99	337	178	379	257	408
20	259	60	307	100	338	180	380	259	409
21	261	61	308	102	339	182	380	261	410
22	262	62	309	104	341	184	381	263	410
23	264	63	310	106	342	186	382	265	411
24	265	64	311	108	343	188	383	267	412
25	267	65	312	110	344	190	384	269	412
26	268	66	313	112	345	192	385	271	413
27	270	67	314	114	347	194	385	273	414
28	271	68	314	116	348	196	386	275	414
29	273	69	315	118	349	198	387	277	415
30	274	70	316	120	350	200	388	279	415
31	276	71	317	122	351	202	389	281	416
32	277	72	318	124	352	204	389	283	417
33	278	73	319	126	353	206	390	285	417
34	280	74	319	128	355	208	391	295	420
35	281	75	320	130	356	210	392	305	423
36	282	76	321	132	357	212	392	355	437
37	283	77	322	134	358	214	393	375	442
38	285	78	322	136	359	216	394	385	445
39	286	79	323	138	360	218	395	405	449
40	287	80	324	140	361	220	395	455	461
41	288	81	325	142	362	222	396	510	472
42	289	82	326	144	363	224	397	560	482
43	290	83	326	146	364	226	398	585	486
44	291	84	327	148	365	228	398		

Fittings & Adapters

We offer a full line of sanitary hose fittings, adapters, and accessories. Fittings are available in 316L stainless steel, 304 stainless steel, electropolished, and in exotic materials such as Hastelloy C22, C276, and Alloy 20. DIN style fittings also available.

Tri-Clamp®

**ELECTROPOLISHING
AVAILABLE!**



*Tri-Clamp® x Barb for Rubber
(HBL Long Barb)*



Mini Tri-Clamp®



Reducing Tri-Clamp®



Reusable Tri-Clamp®



*Tri-Clamp® x Barb for Silicone
(HBS Short Barb)*



Maxi Tri-Clamp®



*PTFE Lined Tri-Clamp®
Not available electropolished*



90° Tri-Clamp® (45° also available)

Bevel Seat



Bevel Seat with Nut

Hose Splice



Barb x Barb

Crimp Collars



NPT Fittings



Female Pipe Thread



Male Pipe Thread

*Consult factory for
other threaded fittings.*

Camlock



PTFE Lined Female Camlock



Male Camlock

Compression Fittings



Compression Tube Adapter



Compression Tube Adapter with Ferrule and Nut



Compression Tube Connector



Compression Tube Connector with Ferrule and Nut

Flanges



Lap Joint Flange Retainer (Insert)



PTFE Encapsulated Lap Joint Flange Retainer (Insert)

JIC Fittings



Female JIC



Male JIC



Male JIC Union Adapter x FPT



Male JIC Union Adapter x MPT

I-Line



Female I-Line



Male I-Line

Buttweld



Buttweld Tube

*Also Available: Buttweld Pipe
Consult factory for details.*

Adapters

ELECTROPOLISHING AVAILABLE!



14MPHR – Hose Barb x TC Adapter



21MP – Male Pipe Thread x TC Adapter



22MP – Female Pipe Thread x TC Adapter



Tri-Clamp® x Hose Barb

Hose ID Inch	Part Number	Description	Fitting ID Inch	Flange Diameter Inch	Fitting Overall Length
1/4	04HB-08TC-SS	.25in Hose Barb x .5in Mini Tri-Clamp®, 316SS	0.19	0.99	1.31
1/4	04HB-12TC-SS	.25in Hose Barb x .75in Mini Tri-Clamp®, 316SS	0.19	0.99	1.31
1/4	04HB-16TC-SS	.25in Hose Barb x 1in Tri-Clamp®, 316SS	0.19	1.98	1.46
3/8	06HB-08TC-SS	.375in Hose Barb x .5in Mini Tri-Clamp®, 316SS	0.28	0.98	1.50
3/8	06HB-12TC-SS	.375in Hose Barb x .75in Mini Tri-Clamp®, 316SS	0.28	0.99	1.50
3/8	06HB-16TC-SS	.375in Hose Barb x 1in Tri-Clamp®, 316SS	0.28	1.98	1.84
1/2	08HB-08TC-SS	.5in Hose Barb x .5in Mini Tri-Clamp®, 316SS	0.37	0.98	1.81
1/2	08HB-12TC-SS	.5in Hose Barb x .75in Mini Tri-Clamp®, 316SS	0.37	0.98	1.81
1/2	08HB-16TC-SS	.5in Hose Barb x 1in Tri-Clamp®, 316SS	0.37	1.98	2.00
5/8	10HB-12TC-SS	.625in Hose Barb x .75in Mini Tri-Clamp®, 316SS	0.48	0.98	1.78
3/4	12HB-12TC-SS	.75in Hose Barb x .75in Mini Tri-Clamp®, 316SS	0.62	0.98	2.10
3/4	12HB-16TC-SS	.75in Hose Barb x 1in Tri-Clamp®, 316SS	0.62	1.98	2.09
1	16HB-16TC-SS	1in Hose Barb x 1in Tri-Clamp®, 316SS	0.87	1.98	2.29
1	16HB-24TC-SS	1in Hose Barb x 1.5in Tri-Clamp®, 316SS	0.87	1.98	2.29
1-1/2	24HBL-24TC-SS	1.5in Long Hose Barb x 1.5in Tri-Clamp®, 316SS	1.36	1.98	3.13
1-1/2	24HBL-32TC-SS	1.5in Long Hose Barb x 2in Tri-Clamp®, 316SS	1.37	2.52	8.13
1-1/2	24HBS-24TC-SS	1.5in Short Hose Barb x 1.5in Tri-Clamp®, 316SS	1.38	1.98	2.33
1-1/2	24HBS-32TC-SS	1.5in Short Hose Barb x 2in Tri-Clamp®, 316SS	1.37	2.52	2.00
2	32HBL-32TC-SS	2in Long Hose Barb x 2in Tri-Clamp®, 316SS	1.84	2.52	3.80
2	32HBS-32TC-SS	2in Short Hose Barb x 2in Tri-Clamp®, 316SS	1.84	2.52	2.39
2-1/2	40HBL-40TC-SS	2.5in Long Hose Barb x 2.5in Tri-Clamp®, 316SS	2.23	3.05	4.19
3	48HBL-48TC-SS	3in Long Hose Barb x 3in Tri-Clamp®, 316SS	2.75	3.58	4.34
3	48HBS-48TC-SS	3in Short Hose Barb x 3in Tri-Clamp®, 316SS	2.75	3.58	3.39
4	64HBL-64TC-SS	4in Long Hose Barb x 4in Tri-Clamp®, 316SS	3.75	4.68	5.00
4	64HBS-64TC-SS	4in Short Hose Barb x 4in Tri-Clamp®, 316SS	3.81	4.68	4.18
6	96HBL-96TC-SS	6in Long Hose Barb x 6in Tri-Clamp®, 316SS	5.75	6.57	6.00
6	96HBS-96TC-SS	6in Silicone Hose Barb x 6in Tri-Clamp®, 316SS	5.75	6.57	5.00

Also available:

304 Stainless Steel
 DIN style fittings
 Step up and step down fittings in all sizes.
 Consult factory for more information.

Note:

Tri-Clamps® larger than 1in have hose barbs that are specially designed for a hose type.

HBL = Long Barb
 Long Barbs are used for PTFE lined and FDA Rubber hoses.

HBS = Short Barb
 Short Barbs are used for Silicone and PVC hoses.



DID YOU KNOW?

Rubber Fab fittings and adapters are also available in **304 Stainless Steel and DIN style fittings**



Reusable Tri-Clamp® Fittings

Hose ID Inch	Part Number	Description	Fitting ID Inch	Flange Diameter Inches	Fitting Overall Length
1/4	04HB-08RTC-SS	.25in HB x .5in Mini TC Reusable Fitting w/Delrin Nut and Sleeve, 316SS	0.18	0.98	1.80
1/4	04HB-12RTC-SS	.25in HB x .75in Mini TC Reusable Fitting w/Delrin Nut and Sleeve, 316SS	0.18	0.98	1.80
3/8	06HB-08RTC-SS	.375in HB x .5in Mini TC Reusable Fitting w/Delrin Nut and Sleeve, 316SS	0.32	0.98	2.00
3/8	06HB-12RTC-SS	.375in HB x .75in Mini TC Reusable Fitting w/Delrin Nut and Sleeve, 316SS	0.32	0.98	2.00
1/2	08HB-08RTC-SS	.5in HB x .5in Mini TC Reusable Fitting w/Delrin Nut and Sleeve, 316SS	0.38	0.98	2.16
1/2	08HB-12RTC-SS	.5in HB x .75in Mini TC Reusable Fitting w/Delrin Nut and Sleeve, 316SS	0.38	0.98	2.16
5/8	10HB-12RTC-SS	.625in HB x .75in Mini TC Reusable Fitting w/Delrin Nut and Sleeve, 316SS	0.50	0.98	2.25
5/8	10HB-16RTC-SS	.625in HB x 1in Tri Clamp Reusable Fitting w/Delrin Nut and Sleeve, 316SS	0.50	1.98	2.25
3/4	12HB-12RTC-SS	.75in HB x .75in Mini TC Reusable Fitting w/Delrin Nut and Sleeve, 316SS	0.63	0.98	2.25
3/4	12HB-16RTC-SS	.75in HB x 1in TC Reusable Fitting w/Delrin Nut and Sleeve, 316SS	0.63	1.98	2.25
1	16HB-16RTC-SS	1in HB x 1in TC Reusable Fitting w/Delrin Nut and Sleeve, 316SS	0.87	1.98	2.50
1	16HB-24RTC-SS	1in HB x 1.5in TC Reusable Fitting w/Delrin Nut and Sleeve, 316SS	0.87	1.98	2.50
1.5	24HBS-24RTC-SS	1.5in Short HB x 1.5in TC Reusable Fitting w/Delrin Nut and Sleeve, 316SS	1.37	1.98	2.65
2	32HBS-32RTC-SS	2in Short HB x 2in TC Reusable Fitting w/Delrin Nut and Sleeve, 316SS	1.75	2.52	3.78

Also available:

Step up and step down fittings in all sizes.
With stainless steel nut, consult factory for more information.

HBS= Short Barb
Short Barbs are used for Silicone and PVC hoses.





Tri-Clamp® Elbow x Hose Barb

Hose ID Inch	Part Number	Description	Elbow ID Inch	Face to Centerline Dimension	Centerline to End of Barb
3/8	06HB-08TC90-SS	.375in Hose Barb x .5in Mini Tri-Clamp® 90 Degree Elbow, 316SS	0.37	1.63	4.96
1/2	08HB-08TC45-SS	.5in Hose Barb x .5in Mini Tri-Clamp® 45 Degree Elbow, 316SS	0.37	1.18	2.42
1/2	08HB-08TC90-SS	.5in Hose Barb x .5in Mini Tri-Clamp® 90 Degree Elbow, 316SS	0.37	1.26	2.50
1/2	08HB-12TC45-SS	.5in Hose Barb x .75in Mini Tri-Clamp® 45 Degree Elbow, 316SS	0.37	1.18	2.42
1/2	08HB-12TC90-SS	.5in Hose Barb x .75in Mini Tri-Clamp® 90 Degree Elbow, 316SS	0.37	1.25	2.50
3/4	12HB-12TC45-SS	.75in Hose Barb x .75in Mini Tri-Clamp® 45 Degree Elbow, 316SS	0.62	0.97	2.47
3/4	12HB-12TC90-SS	.75in Hose Barb x .75in Mini Tri-Clamp® 90 Degree Elbow, 316SS	0.62	1.63	3.13
3/4	12HB-16TC45-SS	.75in Hose Barb x 1in Tri-Clamp® 45 Degree Elbow, 316SS	0.62	0.97	2.47
3/4	12HB-16TC90-SS	.75in Hose Barb x 1in Tri-Clamp® 90 Degree Elbow, 316SS	0.62	1.63	3.13
1	16HB-16TC45-SS	1in Hose Barb x 1in Tri-Clamp® 45 Degree Elbow, 316SS	0.87	CF	CF
1	16HB-16TC90-SS	1in Hose Barb x 1in Tri-Clamp® 90 Degree Elbow, 316SS	0.87	2.01	3.80
1-1/2	24HBL-24TC45-SS	1.5in Long Hose Barb x 1.5in Tri-Clamp® 45 Degree Elbow, 316SS	1.37	1.44	4.06
1-1/2	24HBL-24TC90-SS	1.5in Long Hose Barb x 1.5in Tri-Clamp® 90 Degree Elbow, 316SS	1.37	2.75	5.36
1-1/2	24HBS-24TC45-SS	1.5in Short Hose Barb x 1.5in Tri-Clamp® 45 Degree Elbow, 316SS	1.37	3.80	4.25
1-1/2	24HBS-24TC90-SS	1.5in Short Hose Barb x 1.5in Tri-Clamp® 90 Degree Elbow, 316SS	1.37	2.75	4.54
2	32HBL-32TC45-SS	2in Long Hose Barb x 2in Tri-Clamp® 45 Degree Elbow, 316SS	1.87	4.06	5.81
2	32HBL-32TC90-SS	2in Long Hose Barb x 2in Tri-Clamp® 90 Degree Elbow, 316SS	1.87	3.50	6.50
2	32HBS-32TC45-SS	2in Short Hose Barb x 2in Tri-Clamp® 45 Degree Elbow, 316SS	1.87	1.75	3.64
2	32HBS-32TC90-SS	2in Short Hose Barb x 2in Tri-Clamp® 90 Degree Elbow, 316SS	1.87	3.50	5.39
3	48HBL-48TC45-SS	3in Long Hose Barb x 3in Tri-Clamp® 45 Degree Elbow, 316SS	2.87	2.36	7.38
3	48HBL-48TC90-SS	3in Long Hose Barb x 3in Tri-Clamp® 90 Degree Elbow, 316SS	2.87	5.00	9.34
3	48HBS-48TC45-SS	3in Short Hose Barb x 3in Tri-Clamp® 45 Degree Elbow, 316SS	2.87	2.36	5.75
3	48HBS-48TC90-SS	3in Short Hose Barb x 3in Tri-Clamp® 90 Degree Elbow, 316SS	2.87	5.00	8.16
4	64HBL-64TC45-SS	4in Long Hose Barb x 4in Tri-Clamp® 45 Degree Elbow, 316SS	3.83	3.125	7.90
4	64HBL-64TC90-SS	4in Long Hose Barb x 4in Tri-Clamp® 90 Degree Elbow, 316SS	3.83	6.63	11.00
4	64HBS-64TC45-SS	4in Short Hose Barb x 4in Tri-Clamp® 45 Degree Elbow, 316SS	3.83	3.125	6.30
4	64HBS-64TC90-SS	4in Short Hose Barb x 4in Tri-Clamp® 90 Degree Elbow, 316SS	3.83	6.63	9.80

Also available:

Step up and step down elbow fittings in all sizes.
Consult factory for more information.

HBL= Long Barb

Long Barbs are used for PTFE lined and FDA Rubber hoses.

HBS= Short Barb

Short Barbs are used for Silicone and PVC hoses.

CF = Consult Factory

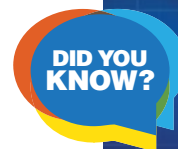

Rubber Fab fittings and adapters are also available in
304 Stainless Steel
and **DIN style fittings**

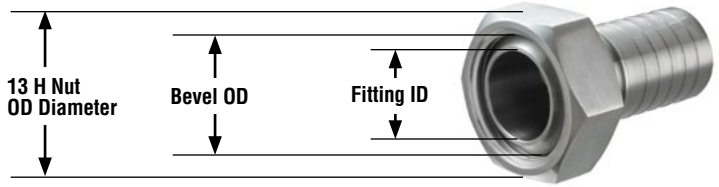

Bevel Seat Fittings

Hose ID Inch	Part Number	Description	Fitting ID Inch	Bevel OD Inch	Fitting Overall Length	13H NUT Part Number	13H NUT Width	13H NUT OD Diameter
1	16HB-16BSI-SS	1in Hose Barb x Bevel Seat Insert, 316SS	0.87	1.32	2.57	16BSNUT-SS	0.91	1.81
1-1/2	24HBL-24BSI-SS	1.5in Long Hose Barb x Bevel Seat Insert, 316SS	1.37	1.85	3.13	24BSNUT-SS	0.97	2.41
2	32HBL-32BSI-SS	2in Long Hose Barb x Bevel Seat Insert, 316SS	1.87	2.38	3.80	32BSNUT-SS	1.06	3.00
2-1/2	40HBL-40BSI-SS	2.5in Long Hose Barb x Bevel Seat Insert, 316SS	2.37	2.91	4.05	40BSNUT-SS	1.19	3.59
3	48HBL-48BSI-SS	3in Long Hose Barb x Bevel Seat Insert, 316SS	2.87	3.44	4.75	48BSNUT-SS	1.26	4.19
4	64HBL-64BSI-SS	4in Long Hose Barb x Bevel Seat Insert, 316SS	3.83	4.51	6.01	64BSNUT-SS	1.50	5.44

Also requires 13H nut sold separately.



Female Pipe Thread (FPT)

Hose ID Inch	Part Number	Description	Fitting Inside Barb Diameter Inch	Fitting Inside FPT Diameter Inch	Fitting FPT Outside Diameter Inch	Fitting Overall Length
1/4	04HB-04FPT-SS	.25in Hose Barb x Female Pipe Thread, 316SS	0.19	0.43	0.75	1.63
3/8	06HB-06FPT-SS	.375in Hose Barb x Female Pipe Thread, 316SS	0.28	0.58	0.87	1.73
1/2	08HB-08FPT-SS	.5in Hose Barb x Female Pipe Thread, 316SS	0.39	0.71	1.06	2.25
3/4	12HB-12FPT-SS	.75in Hose Barb x Female Pipe Thread, 316SS	0.63	0.92	1.31	2.61
1	16HB-16FPT-SS	1in Hose Barb x Female Pipe Thread, 316SS	0.86	1.14	1.62	2.84
1-1/2	24HBL-24FPT-SS	1.5in Long Hose Barb x Female Pipe Thread, 316SS	1.36	1.69	3.03	3.17
2	32HBL-32FPT-SS	2in Long Hose Barb x Female Pipe Thread, 316SS	1.75	2.00	2.50	3.89



Male Pipe Thread (MPT)

Hose ID Inch	Part Number	Description	Fitting Inside Diameter Inch	Threaded Outside Diameter Inch	Fitting Overall Length
1/4	04HB-04MPT-SS	.25in Hose Barb x Male Pipe Thread, 316SS	0.19	0.54	1.63
3/8	06HB-06MPT-SS	.375in Hose Barb x Male Pipe Thread, 316SS	0.28	0.68	1.76
1/2	08HB-08MPT-SS	.5in Hose Barb x Male Pipe Thread, 316SS	0.39	0.85	2.34
3/4	12HB-12MPT-SS	.75in Hose Barb x Male Pipe Thread, 316SS	0.63	1.03	2.53
1	16HB-16MPT-SS	1in Hose Barb x Male Pipe Thread, 316SS	0.84	1.31	2.92
1-1/2	24HBL-24MPT-SS	1.5in Long Hose Barb x Male Pipe Thread, 316SS	1.63	1.89	4.17
2	32HBL-32MPT-SS	2in Long Hose Barb x Male Pipe Thread, 316SS	1.75	2.36	4.58



Compression Tube Adapter

Hose ID Inch	Part Number	Description	Fitting ID Inch	Flange OD Inch	Fitting Overall Length
1/4	04HB-04CTA-SS	.25in Hose Barb x CTA, 316SS	0.19	0.25	1.75
3/8	06HB-06CTA-SS	.375in Hose Barb x CTA, 316SS	0.28	0.38	2.07
1/2	08HB-08CTA-SS	.5in Hose Barb x CTA, 316SS	0.38	0.50	2.57
3/4	12HB-12CTA-SS	.75in Hose Barb x CTA, 316SS	0.62	0.75	2.86
1	16HB-16CTA-SS	1in Hose Barb x CTA, 316SS	0.86	1.00	3.33



Compression Tube Adapter w/Ferrule & Nut

Hose ID Inch	Part Number	Description	Fitting ID Inch	Flange OD Inch	Fitting Overall Length
1/4	04HB-04CTAFN-SS	.25in Hose Barb x CTA w/Ferrule & Nut, 316SS	0.19	0.25	1.75
3/8	06HB-06CTAFN-SS	.375in Hose Barb x CTA w/Ferrule & Nut, 316SS	0.28	0.38	2.07
1/2	08HB-08CTAFN-SS	.5in Hose Barb x CTA w/Ferrule & Nut, 316SS	0.38	0.50	2.57
3/4	12HB-12CTAFN-SS	.75in Hose Barb x CTA w/Ferrule & Nut, 316SS	0.62	0.75	2.86
1	16HB-16CTAFN-SS	1in Hose Barb x CTA w/Ferrule & Nut, 316SS	0.86	1.00	3.33



Compression Tube Connector

Hose ID Inch	Part Number	Description	Fitting Tube ID Inch	Fitting Barb ID Inch	Fitting Overall Length
1/4	04HB-04CTC-SS	.25in Hose Barb x CTC, 316SS	0.26	0.19	1.43
3/8	06HB-06CTC-SS	.375in Hose Barb x CTC, 316SS	0.38	0.28	1.71
1/2	08HB-08CTC-SS	.5in Hose Barb x CTC, 316SS	0.50	0.39	2.05
3/4	12HB-12CTC-SS	.75in Hose Barb x CTC, 316SS	0.75	0.65	2.50
1	16HB-16CTC-SS	1in Hose Barb x CTC, 316SS	1.00	0.87	2.61



Compression Tube Connector w/Ferrule & Nut

Hose ID Inch	Part Number	Description	Fitting Tube ID Inch	Fitting Barb ID Inch	Fitting Overall Length
1/4	04HB-04CTCFN-SS	.25in Hose Barb x CTC w/Ferrule & Nut, 316SS	0.26	0.19	1.43
3/8	06HB-06CTCFN-SS	.375in Hose Barb x CTC w/Ferrule & Nut, 316SS	0.38	0.28	1.71
1/2	08HB-08CTCFN-SS	.5in Hose Barb x CTC w/Ferrule & Nut, 316SS	0.50	0.39	2.05
3/4	12HB-12CTCFN-SS	.75in Hose Barb x CTC w/Ferrule & Nut, 316SS	0.75	0.65	2.81
1	16HB-16CTCFN-SS	1in Hose Barb x CTC w/Ferrule & Nut, 316SS	1.00	0.87	2.96



Lap Joint Flange Insert

Nominal Pipe Size Inch	Part Number	Description	ID Inch	Fitting Face Diameter Inch	Overall Length
1/2	08HB-08LJFR-SS	.5in Hose Barb x Lap Joint Flange Insert, 316SS	0.38	1.38	2.29
3/4	12HB-12LJFR-SS	.75in Hose Barb x Lap Joint Flange Insert, 316SS	0.63	1.68	2.38
1	16HB-16LJFR-SS	1in Hose Barb x Lap Joint Flange Insert, 316SS	0.84	2.00	3.15
1-1/2	24HBL-24LJFR-SS	1.5in Long Hose Barb x Lap Joint Flange Insert, 316SS	1.36	2.87	3.65
2	32HBL-32LJFR-SS	2in Long Hose Barb x Lap Joint Flange Insert, 316SS	1.75	3.63	4.15
2-1/2	40HBL-40LJFR-SS	2.5in Long Hose Barb x Lap Joint Flange Insert, 316SS	2.22	4.12	5.22
3	48HBL-48LJFR-SS	3in Long Hose Barb x Lap Joint Flange Insert, 316SS	2.87	4.98	5.39
4	64HBL-64LJFR-SS	4in Long Hose Barb x Lap Joint Flange Insert, 316SS	CF	CF	CF

CF = Consult Factory

Insert also available:

PTFE Encapsulated.

Consult factory for dimensions and sizes available.



150# Ansi Flange

Nominal Pipe Size Inch	Part Number	Description	Outside Flange Diameter Inch	Flange Thickness Inch	Number of Holes	Diameter Bolts Inch	Bolt Circle Inch
1/2	08-150LJF-SS	.5in 150# Lap Joint Ansi Flange, 316SS	3-1/2	7/16	4	1/2	2-3/8
3/4	12-150LJF-SS	.75in 150# Lap Joint Ansi Flange, 316SS	3-7/8	1/2	4	1/2	2-3/4
1	16-150LJF-SS	1in 150# Lap Joint Ansi Flange, 316SS	4-1/4	9/16	4	1/2	3-1/8
1-1/2	24-150LJF-SS	1.5in 150# Lap Joint Ansi Flange, 316SS	5	11/16	4	1/2	3-7/8
2	32-150LJF-SS	2in 150# Lap Joint Ansi Flange, 316SS	6	3/4	4	5/8	4-3/4
2-1/2	40-150LJF-SS	2.5in 150# Lap Joint Ansi Flange, 316SS	7	7/8	4	5/8	5-1/2
3	48-150LJF-SS	3in 150# Lap Joint Ansi Flange, 316SS	7-1/2	15/16	4	5/8	6
4	64-150LJF-SS	4in 150# Lap Joint Ansi Flange, 316SS	9	15/16	8	5/8	7-1/2

Flange also available:

304 Stainless Steel

Carbon Steel

Polypropylene

Kynar®



150# Lap Joint Ansi Flange

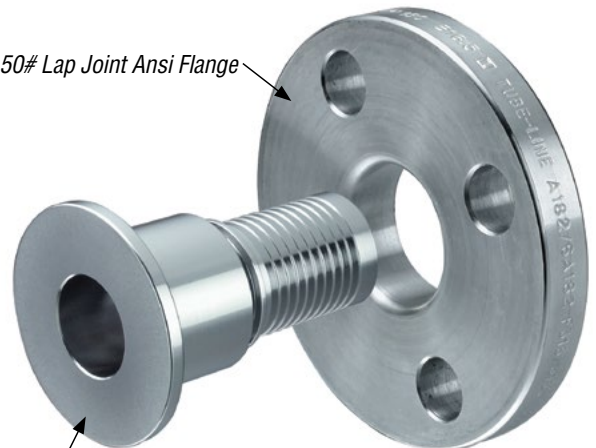

Lap Joint Flange Retainer (Insert)



Female JIC Fittings w/Nut

Hose ID Inch	Part Number	Description	Fitting Tube ID Inch	Barb ID Inch	Fitting Overall Length
1/4	04HB-04FJICI-SS	.25in Hose Barb x Female JIC w/Nut, 316SS	0.18	0.18	1.07
3/8	06HB-06FJICI-SS	.375in Hose Barb x Female JIC w/Nut, 316SS	0.28	0.28	1.38
1/2	08HB-08FJICI-SS	.5in Hose Barb x Female JIC w/Nut, 316SS	0.38	0.38	1.68
3/4	12HB-12FJICI-SS	.75in Hose Barb x Female JIC w/Nut, 316SS	0.64	0.64	1.98
1	16HB-16FJICI-SS	1in Hose Barb x Female JIC w/Nut, 316SS	0.86	0.86	2.14
1-1/2	24HB-24FJICI-SS	1.5in Hose Barb x Female JIC w/Nut, 316SS	1.27	1.27	2.78
2	32HB-32FJICI-SS	2in Hose Barb x Female JIC w/Nut, 316SS	1.75	1.75	3.61

Also available:

HBL and HBS style barb.



Male JIC Union Adapter x MPT

Hose ID Inch	Part Number	Description	Male 37° Flare	Male NPT Size	Fitting Overall Length
1/4	04MUA-04MPT-SS	.25in Male JIC Union Adapter x Male Pipe Thread, 316SS	1/4	1/4 - 18	1.42
3/8	06MUA-06MPT-SS	.375in Male JIC Union Adapter x Male Pipe Thread, 316SS	3/8	3/8 - 18	1.43
1/2	08MUA-08MPT-SS	.5in Male JIC Union Adapter x Male Pipe Thread, 316SS	1/2	1/2 - 14	1.79
3/4	12MUA-12MPT-SS	.75in Male JIC Union Adapter x Male Pipe Thread, 316SS	3/4	3/4 - 14	2.06
1	16MUA-16MPT-SS	1in Male JIC Union Adapter x Male Pipe Thread, 316SS	1	1 - 11-1/2	2.30
1-1/2	24MUA-24MPT-SS	1.5in Male JIC Union Adapter x Male Pipe Thread, 316SS	1-1/2	1-1/2 - 11-1/2	2.68
2	32MUA-32MPT-SS	2in Male JIC Union Adapter x Male Pipe Thread, 316SS	2	2 - 11-1/2	3.11

Also available:

Step up and step down in all sizes.
Consult factory for more information.



Male JIC Union Adapter x FPT

Hose ID Inch	Part Number	Description	Male 37° Flare	Female NPT Size	Fitting Overall Length
1/4	04MUA-04FPT-SS	.25in Male JIC Union Adapter x Female Pipe Thread, 316SS	1/4	1/4 - 18	1.39
3/8	06MUA-06FPT-SS	.375in Male JIC Union Adapter x Female Pipe Thread, 316SS	3/8	3/8 - 18	1.46
1/2	08MUA-08FPT-SS	.5in Male JIC Union Adapter x Female Pipe Thread, 316SS	1/2	1/2 - 14	1.79
3/4	12MUA-12FPT-SS	.75in Male JIC Union Adapter x Female Pipe Thread, 316SS	3/4	3/4 - 14	2.06
1	16MUA-16FPT-SS	1in Male JIC Union Adapter x Female Pipe Thread, 316SS	1	1 - 11-1/2	2.35
1-1/2	24MUA-24FPT-SS	1.5in Male JIC Union Adapter x Female Pipe Thread, 316SS	1-1/2	1-1/2 - 11-1/2	2.62
2	32MUA-32FPT-SS	2in Male JIC Union Adapter x Female Pipe Thread, 316SS	2	2 - 11-1/2	2.97

Also available:

Step up and step down in all sizes.
Consult factory for more information.

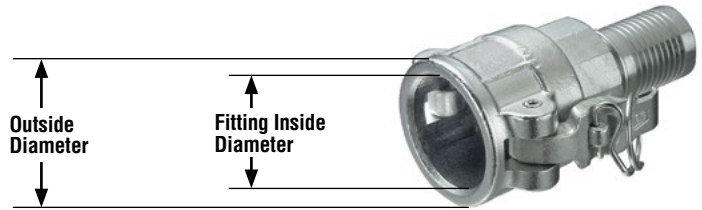

Female Camlock Fittings

Hose ID Inch	Part Number	Description	Fitting ID Inch
3/4	12HB-12FCL-SS	.75in Hose Barb x .75in Female Camlock, Locking, Swivel, 316SS	1.30
1	16HB-16FCL-SS	1in Hose Barb x 1in Female Camlock, Locking, Swivel, 316SS	1.48
1-1/2	24HBL-24FCL-SS	1.5in Long Hose Barb x 1.5in Female Camlock, Locking, Swivel, 316SS	2.15
2	32HBL-32FCL-SS	2in Long Hose Barb x 2in Female Camlock, Locking, Swivel, 316SS	2.53
2-1/2	40HBL-40FCL-SS-NL	2.5in Long Hose Barb x 2.5in Female Camlock, Non-Locking, 316SS	3.00
3	48HBL-48FCL-316	3in Long Hose Barb x 3in Female Camlock, Locking, 316SS	3.65
4	64HBL-64FCL-316-NS	4in Long Hose Barb x 4in Female Camlock, Locking, 316SS	4.75

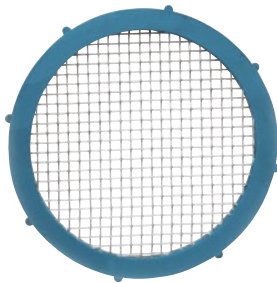

Also available:
HBS style barb.
Non-swivel fittings.

Reusable Camlock Screens, Perforated Plates, Sock Screens and Orifice Plates are available in 1"-4".



Male Camlock Fittings

Hose ID Inch	Part Number	Description	Flange OD Inch
3/4	12HB-12MCL-SS	.75in Hose Barb x Male Camlock, 316SS	1.26
1	16HB-16MCL-SS	1in Hose Barb x Male Camlock, 316SS	1.44
1-1/2	24HBL-24MCL-SS	1.5in Long Hose Barb x Male Camlock, 316SS	2.10
2	32HBL-32MCL-SS	2in Long Hose Barb x Male Camlock, 316SS	2.48
2-1/2	40HBL-40MCL-SS	2.5in Long Hose Barb x Male Camlock, 316SS	2.90
3	48HBL-48MCL-SS	3in Long Hose Barb x Male Camlock, 316SS	3.59
4	64HBL-64MCL-SS	4in Long Hose Barb x Male Camlock, 316SS	4.70

Also available:
HBS style barb.



Female I-Line

Hose ID Inch	Part Number	Description	Fitting ID Inch	Flange OD Inch	Fitting Overall Length
1	16HB-16FMIL-SS	1in Hose Barb x Female I-Line, 316SS	0.87	1.99	3.08
1-1/2	24HBL-24FMIL-SS	1.5in Long Hose Barb x Female I-Line, 316SS	1.38	1.99	4.07
2	32HBL-32FMIL-SS	2in Long Hose Barb x Female I-Line, 316SS	1.84	2.64	4.54
2-1/2	40HBL-40FMIL-SS	2.5in Long Hose Barb x Female I-Line, 316SS	2.23	3.31	5.35
3	48HBL-48FMIL-SS	3in Long Hose Barb x Female I-Line, 316SS	2.75	3.87	5.56
4	64HBL-64FMIL-SS	4in Long Hose Barb x Female I-Line, 316SS	3.75	4.87	6.35

Consult factory for short barb style.



Male I-Line

Hose ID Inch	Part Number	Description	Fitting ID Inch	Flange OD Inch	Fitting Overall Length
1	16HB-16MIL-SS	1in Hose Barb x Male I-Line, 316SS	0.87	1.99	3.08
1-1/2	24HBL-24MIL-SS	1.5in Long Hose Barb x Male I-Line, 316SS	1.38	1.99	4.07
2	32HBL-32MIL-SS	2in Long Hose Barb x Male I-Line, 316SS	1.84	2.64	4.54
2-1/2	40HBL-40MIL-SS	2.5in Long Hose Barb x Male I-Line, 316SS	2.23	3.31	5.35
3	48HBL-48MIL-SS	3in Long Hose Barb x Male I-Line, 316SS	2.75	3.87	5.56
4	64HBL-64MIL-SS	4in Long Hose Barb x Male I-Line, 316SS	3.75	4.87	6.35

Consult factory for short barb style.



Q-Line

Q-Line fittings also available, consult factory for sizing and availability.

John Perry

John Perry fittings also available, consult factory for sizing and availability.



Rubber Fab fittings and adapters are also available in **304 Stainless Steel.**

CONSULT FACTORY FOR DETAILS.



Butt Weld Tube

Hose ID Inch	Part Number	Description	Fitting Tube ID Inch	Barb ID Inch	Fitting Overall Length
1/4	04HB-04BWT-SS	.25in Hose Barb x .25in Butt Weld Tube, 316SS	0.15	0.16	1.13
3/8	06HB-06BWT-SS	.375in Hose Barb x .375in Butt Weld Tube, 316SS	0.28	0.28	1.38
1/2	08HB-08BWT-SS	.5in Hose Barb x .5in Butt Weld Tube, 316SS	0.37	0.37	1.75
3/4	12HB-12BWT-SS	.75in Hose Barb x .75in Butt Weld Tube, 316SS	0.62	0.62	2.00
1	16HB-16BWT-SS	1in Hose Barb x 1in Butt Weld Tube, 316SS	0.87	0.87	2.29
1-1/2	24HBL-24BWT-SS	1.5in Long Hose Barb x 1.5in Butt Weld Tube, 316SS	1.37	1.37	3.13
1-1/2	24HBS-24BWT-SS	1.5in Short Hose Barb x 1.5in Butt Weld Tube, 316SS	1.37	1.37	2.29
2	32HBL-32BWT-SS	2in Long Hose Barb x 2in Butt Weld Tube, 316SS	1.84	1.84	3.50
2	32HBS-32BWT-SS	2in Short Hose Barb x 2in Butt Weld Tube, 316SS	1.84	1.84	2.39
2-1/2	40HBL-40BWT-SS	2.5in Long Hose Barb x 2.5in Butt Weld Tube, 316SS	2.36	2.23	4.19
2-1/2	40HBS-40BWT-SS	2.5in Short Hose Barb x 2.5in Butt Weld Tube, 316SS	2.25	2.25	2.88
3	48HBL-48BWT-SS	3in Long Hose Barb x 3in Butt Weld Tube, 316SS	2.87	2.67	4.66
3	48HBS-48BWT-SS	3in Short Hose Barb x 3in Butt Weld Tube, 316SS	2.87	2.75	3.39
4	64HBL-64BWT-SS	4in Long Hose Barb x 4in Butt Weld Tube, 316SS	3.83	3.75	5.00
4	64HBS-64BWT-SS	4in Short Hose Barb x 4in Butt Weld Tube, 316SS	3.83	3.81	3.68
6	96HBL-96BWT-SS	6in Long Hose Barb x 6in Butt Weld Tube, 316SS	5.75	5.75	6.00
6	96HBS-96BWT-SS	6in Short Hose Barb X 6in Butt Weld Tube, 316SS	5.75	5.75	5.00

Also available:

Butt weld pipe, consult factory for sizing and availability.

Non-Metallic Fittings & Adapters

Rubber Fab offers a full line of non-metallic sanitary hose fittings, adapters, clamps, and sanitary fitting end caps.



14MPHR- 316 Stainless Steel Tri-Clamp® Adapters

Part Number	Part Description
14MPHR-02HB-08TC-SS	14MPHR .125in Hose Barb x .5in Tri-Clamp®, 316SS
14MPHR-02HB-12TC-SS	14MPHR .125in Hose Barb x .75in Tri-Clamp®, 316SS
14MPHR-02HB-16TC-SS	14MPHR .125in Hose Barb x 1in Tri-Clamp®, 316SS
14MPHR-02HB-24TC-SS	14MPHR .125in Hose Barb x 1.5in Tri-Clamp®, 316SS
14MPHR-03HB-08TC-SS	14MPHR .187in Hose Barb x .5in Tri-Clamp®, 316SS
14MPHR-03HB-12TC-SS	14MPHR .187in Hose Barb x .75in Tri-Clamp®, 316SS
14MPHR-03HB-24TC-SS	14MPHR .187in Hose Barb x 1.5in Tri-Clamp®, 316SS
14MPHR-04HB-08TC-SS	14MPHR .25in Hose Barb x .5in Tri-Clamp®, 316SS
14MPHR-04HB-12TC-SS	14MPHR .25in Hose Barb x .75in Tri-Clamp®, 316SS
14MPHR-04HB-16TC-SS	14MPHR .25in Hose Barb x 1in Tri-Clamp®, 316SS
14MPHR-04HB-24TC-SS	14MPHR .25in Hose Barb x 1.5in Tri-Clamp®, 316SS
14MPHR-05HB-08TC-SS	14MPHR .312in Hose Barb x .5in Tri-Clamp®, 316SS
14MPHR-06HB-08TC-SS	14MPHR .375in Hose Barb x .5in Tri-Clamp®, 316SS
14MPHR-06HB-12TC-SS	14MPHR .375in Hose Barb x .75in Tri-Clamp®, 316SS
14MPHR-06HB-16TC-SS	14MPHR .375in Hose Barb x 1in Tri-Clamp®, 316SS
14MPHR-06HB-24TC-SS	14MPHR .375in Hose Barb x 1.5in Tri-Clamp®, 316SS
14MPHR-06HB-32TC-SS	14MPHR .375in Hose Barb x 2in Tri-Clamp®, 316SS
14MPHR-06HB-48TC-SS	14MPHR .375in Hose Barb x 3in Tri-Clamp®, 316SS
14MPHR-08HB-08TC-SS	14MPHR .5in Hose Barb x .5in Tri-Clamp®, 316SS
14MPHR-08HB-12TC-SS	14MPHR .5in Hose Barb x .75in Tri-Clamp®, 316SS
14MPHR-08HB-16TC-SS	14MPHR .5in Hose Barb x 1in Tri-Clamp®, 316SS
14MPHR-08HB-24TC-SS	14MPHR .5in Hose Barb x 1.5in Tri-Clamp®, 316SS
14MPHR-08HB-32TC-SS	14MPHR .5in Hose Barb x 2in Tri-Clamp®, 316SS
14MPHR-10HB-08TC-SS	14MPHR .625in Hose Barb x .5in Tri-Clamp®, 316SS
14MPHR-10HB-12TC-SS	14MPHR .625in Hose Barb x .75in Tri-Clamp®, 316SS
14MPHR-10HB-16TC-SS	14MPHR .625in Hose Barb x 1in Tri-Clamp®, 316SS
14MPHR-10HB-24TC-SS	14MPHR .625in Hose Barb x 1.5in Tri-Clamp®, 316SS
14MPHR-12HB-12TC-SS	14MPHR .75in Hose Barb x .75in Tri-Clamp®, 316SS
14MPHR-12HB-16TC-SS	14MPHR .75in Hose Barb x 1in Tri-Clamp®, 316SS
14MPHR-12HB-24TC-SS	14MPHR .75in Hose Barb x 1.5in Tri-Clamp®, 316SS
14MPHR-12HB-32TC-SS	14MPHR .75in Hose Barb x 2in Tri-Clamp®, 316SS
14MPHR-14HB-24TC-SS	14MPHR .875in Hose Barb x 1.5in Tri-Clamp®, 316SS
14MPHR-16HB-16TC-SS	14MPHR 1in Hose Barb x 1in Tri-Clamp®, 316SS
14MPHR-16HB-24TC-SS	14MPHR 1in Hose Barb x 1.5in Tri-Clamp®, 316SS
14MPHR-16HB-32TC-SS	14MPHR 1in Hose Barb x 2in Tri-Clamp®, 316SS
14MPHR-20HB-24TC-SS	14MPHR 1.25in Hose Barb x 1.5in Tri-Clamp®, 316SS
14MPHR-24HB-24TC-SS	14MPHR 1.5in Hose Barb x 1.5in Tri-Clamp®, 316SS
14MPHR-24HB-32TC-SS	14MPHR 1.5in Hose Barb x 2in Tri-Clamp®, 316SS
14MPHR-32HB-32TC-SS	14MPHR 2in Hose Barb x 2in Tri-Clamp®, 316SS
14MPHR-32HB-40TC-SS	14MPHR 2in Hose Barb x 2.5in Tri-Clamp®, 316SS
14MPHR-40HB-40TC-SS	14MPHR 2.5in Hose Barb x 2.5in Tri-Clamp®, 316SS
14MPHR-48HB-48TC-SS	14MPHR 3in Hose Barb x 3in Tri-Clamp®, 316SS



Also available:
 Step up and step down adapters
 in all sizes and in these materials:
 304 Stainless Steel
 Polypropylene
 Kynar®
 Hastelloy
 Exotic Metals
 Electropolished Finish



16AMP- 316 Stainless Steel Tri-Clamp® End Cap

Part Number	Part Description
16AMP-075-316	.5in/.75in 316SS Tri-Clamp® End Cap
16AMP-150-316	1.5in 316SS Tri-Clamp® End Cap
16AMP-200-316	2in 316SS Tri-Clamp® End Cap
16AMP-250-316	2.5in 316SS Tri-Clamp® End Cap
16AMP-300-316	3in 316SS Tri-Clamp® End Cap
16AMP-400-316	4in 316SS Tri-Clamp® End Cap
16AMP-600-316	6in 316SS Tri-Clamp® End Cap
16AMP-800-316	8in 316SS Tri-Clamp® End Cap
16AMP-1000-316	10in 316SS Tri-Clamp® End Cap
16AMP-050/075-316L-HDL	.5in/.75in 316SS Tri-Clamp® End Cap with Handle
16AMP-100/150-316L-HDL	1in/1.5in 316SS Tri-Clamp® End Cap with Handle
16AMP-200-316L-HDL	2in 316SS Tri-Clamp® End Cap with Handle
16AMP-250-316L-HDL	2.5in 316SS Tri-Clamp® End Cap with Handle
16AMP-300-316L-HDL	3in 316SS Tri-Clamp® End Cap with Handle
16AMP-075-K	.75in PVDF Tri-Clamp® End Cap
16AMP-150-K	1.5in PVDF Tri-Clamp® End Cap
16AMP-200-K	2in PVDF Tri-Clamp® End Cap
16AMP-250-K	2.5in PVDF Tri-Clamp® End Cap
16AMP-300-K	3in PVDF Tri-Clamp® End Cap
16AMP-400-K	4in PVDF Tri-Clamp® End Cap
16AMP-075-PP	.75in Polypro Tri-Clamp® End Cap
16AMP-150-PP	1.5in Polypro Tri-Clamp® End Cap
16AMP-200-PP	2in Polypro Tri-Clamp® End Cap
16AMP-250-PP	2.5in Polypro Tri-Clamp® End Cap
16AMP-300-PP	3in Polypro Tri-Clamp® End Cap
16AMP-400-PP	4in Polypro Tri-Clamp® End Cap
16AMP-600-PP	6in Polypro Tri-Clamp® End Cap



Also available:

Step up and step down adapters in all sizes and in these materials:
 304 Stainless Steel
 Polypropylene
 Kynar®
 Hastelloy
 Exotic Metals
 Electropolished Finish

DID YOU KNOW?

Rubber Fab fittings and adapters are also available in **304 Stainless Steel.**

CONSULT FACTORY FOR DETAILS.

21MP Adapters (Tri-Clamp® x Male Pipe Thread)

Part Number	Part Description
21MP-08TC-04MPT-SS	.5in Mini Tri-Clamp® x .25in Male Pipe Thread Adapter, 316SS
21MP-08TC-06MPT-SS	.5in Mini Tri-Clamp® x .375in Male Pipe Thread Adapter, 316SS
21MP-08TC-08MPT-SS	.5in Mini Tri-Clamp® x .5in Male Pipe Thread Adapter, 316SS
21MP-08TC-12MPT-SS	.5in Mini Tri-Clamp® x .75in Male Pipe Thread Adapter, 316SS
21MP-12TC-02MPT-SS	.75in Mini Tri-Clamp® x .125in Male Pipe Thread Adapter, 316SS
21MP-12TC-04MPT-SS	.75in Mini Tri-Clamp® x .25in Male Pipe Thread Adapter, 316SS
21MP-12TC-06MPT-SS	.75in Mini Tri-Clamp® x .375in Male Pipe Thread Adapter, 316SS
21MP-12TC-08MPT-SS	.75in Mini Tri-Clamp® x .5in Male Pipe Thread Adapter, 316SS
21MP-12TC-12MPT-SS	.75in Mini Tri-Clamp® x .75in Male Pipe Thread Adapter, 316SS
21MP-12TC-16MPT-SS	.75in Mini Tri-Clamp® x 1in Male Pipe Thread Adapter, 316SS
21MP-16TC-04MPT-SS	1in Tri-Clamp® x .25in Male Pipe Thread Adapter, 316SS
21MP-16TC-06MPT-SS	1in Tri-Clamp® x .375in Male Pipe Thread Adapter, 316SS
21MP-16TC-08MPT-SS	1in Tri-Clamp® x .5in Male Pipe Thread Adapter, 316SS
21MP-16TC-12MPT-SS	1in Tri-Clamp® x .75in Male Pipe Thread Adapter, 316SS
21MP-16TC-16MPT-SS	1in Tri-Clamp® x 1in Male Pipe Thread Adapter, 316SS
21MP-16TC-20MPT-SS	1in Tri-Clamp® x 1.25in Male Pipe Thread Adapter, 316SS
21MP-16TC-24MPT-SS	1in Tri-Clamp® x 1.5in Male Pipe Thread Adapter, 316SS
21MP-16TC-32MPT-SS	1in Tri-Clamp® x 2in Male Pipe Thread Adapter, 316SS
21MP-24TC-04MPT-SS	1.5in Tri-Clamp® x .25in Male Pipe Thread Adapter, 316SS
21MP-24TC-08MPT-SS	1.5in Tri-Clamp® x .5in Male Pipe Thread Adapter, 316SS
21MP-24TC-12MPT-SS	1.5in Tri-Clamp® x .75in Male Pipe Thread Adapter, 316SS
21MP-24TC-16MPT-SS	1.5in Tri-Clamp® x 1in Male Pipe Thread Adapter, 316SS
21MP-24TC-20MPT-SS	1.5in Tri-Clamp® x 1.25in Male Pipe Thread Adapter, 316SS
21MP-24TC-24MPT-SS	1.5in Tri-Clamp® x 1.5in Male Pipe Thread Adapter, 316SS
21MP-24TC-32MPT-SS	1.5in Tri-Clamp® x 2in Male Pipe Thread Adapter, 316SS
21MP-32TC-04MPT-SS	2in Tri-Clamp® x .25in Male Pipe Thread Adapter, 316SS
21MP-32TC-08MPT-SS	2in Tri-Clamp® x .5in Male Pipe Thread Adapter, 316SS
21MP-32TC-12MPT-SS	2in Tri-Clamp® x .75in Male Pipe Thread Adapter, 316SS
21MP-32TC-20MPT-SS	2in Tri-Clamp® x 1.25in Male Pipe Thread Adapter, 316SS
21MP-32TC-24MPT-SS	2in Tri-Clamp® x 1.5in Male Pipe Thread Adapter, 316SS
21MP-32TC-32MPT-SS	2in Tri-Clamp® x 2in Male Pipe Thread Adapter, 316SS
21MP-40TC-32MPT-SS	2.5in Tri-Clamp® x 2in Male Pipe Thread Adapter, 316SS
21MP-48TC-32MPT-SS	3in Tri-Clamp® x 2in Male Pipe Thread Adapter, 316SS



Also available:

Step up and step down adapters
in all sizes and in these materials:

304 Stainless Steel

Polypropylene

Kynar®

Hastelloy

Exotic Metals

Electropolished Finish



22MP Adapters (Tri-Clamp® x Female Pipe Thread)

Part Number	Part Description
22MP-08TC-02FPT-SS	.5in Mini Tri-Clamp® x .125in Female Pipe Thread Adapter, 316SS
22MP-08TC-04FPT-SS	.5in Mini Tri-Clamp® x .25in Female Pipe Thread Adapter, 316SS
22MP-08TC-06FPT-SS	.5in Mini Tri-Clamp® x .375in Female Pipe Thread Adapter, 316SS
22MP-08TC-08FPT-SS	.5in Mini Tri-Clamp® x .5in Female Pipe Thread Adapter, 316SS
22MP-08TC-12FPT-SS	.5in Mini Tri-Clamp® x .75in Female Pipe Thread Adapter, 316SS
22MP-08TC-16FPT-SS	.5in Mini Tri-Clamp® x 1in Female Pipe Thread Adapter, 316SS
22MP-12TC-02FPT-SS	.75in Mini Tri-Clamp® x .125in Female Pipe Thread Adapter, 316SS
22MP-12TC-04FPT-SS	.75in Mini Tri-Clamp® x .25in Female Pipe Thread Adapter, 316SS
22MP-12TC-06FPT-SS	.75in Mini Tri-Clamp® x .375in Female Pipe Thread Adapter, 316SS
22MP-12TC-08FPT-SS	.75in Mini Tri-Clamp® x .5in Female Pipe Thread Adapter, 316SS
22MP-12TC-12FPT-SS	.75in Mini Tri-Clamp® x .75in Female Pipe Thread Adapter, 316SS
22MP-12TC-16FPT-SS	.75in Mini Tri-Clamp® x 1in Female Pipe Thread Adapter, 316SS
22MP-16TC-04FPT-SS	1in Tri-Clamp® x .25in Female Pipe Thread Adapter, 316SS
22MP-16TC-06FPT-SS	1in Tri-Clamp® x .375in Female Pipe Thread Adapter, 316SS
22MP-16TC-08FPT-SS	1in Tri-Clamp® x .5in Female Pipe Thread Adapter, 316SS
22MP-16TC-12FPT-SS	1in Tri-Clamp® x .75in Female Pipe Thread Adapter, 316SS
22MP-16TC-16FPT-SS	1in Tri-Clamp® x 1in Female Pipe Thread Adapter, 316SS
22MP-16TC-24FPT-SS	1in Tri-Clamp® x 1.5in Female Pipe Thread Adapter, 316SS
22MP-16TC-32FPT-SS	1in Tri-Clamp® x 2in Female Pipe Thread Adapter, 316SS
22MP-24TC-04FPT-SS	1.5in Tri-Clamp® x .25in Female Pipe Thread Adapter, 316SS
22MP-24TC-08FPT-SS	1.5in Tri-Clamp® x .5in Female Pipe Thread Adapter, 316SS
22MP-24TC-12FPT-SS	1.5in Tri-Clamp® x .75in Female Pipe Thread Adapter, 316SS
22MP-24TC-16FPT-SS	1.5in Tri-Clamp® x 1in Female Pipe Thread Adapter, 316SS
22MP-24TC-24FPT-SS	1.5in Tri-Clamp® x 1.5in Female Pipe Thread Adapter, 316SS
22MP-24TC-32FPT-SS	1.5in Tri-Clamp® x 2in Female Pipe Thread Adapter, 316SS
22MP-24TC-40FPT-SS	1.5in Tri-Clamp® x 2.5in Female Pipe Thread Adapter, 316SS
22MP-32TC-08FPT-SS	2in Tri-Clamp® x .5in Female Pipe Thread Adapter, 316SS
22MP-32TC-12FPT-SS	2in Tri-Clamp® x .75in Female Pipe Thread Adapter, 316S
22MP-32TC-16FPT-SS	2in Tri-Clamp® x 1in Female Pipe Thread Adapter, 316SS
22MP-32TC-24FPT-SS	2in Tri-Clamp® x 1.5in Female Pipe Thread Adapter, 316SS
22MP-32TC-32FPT-SS	2in Tri-Clamp® x 2in Female Pipe Thread Adapter, 316SS
22MP-40TC-40FPT-SS	2.5in Tri-Clamp® x 2.5in Female Pipe Thread Adapter, 316SS
22MP-48TC-48FPT-SS	3in Tri-Clamp® x 3in Female Pipe Thread Adapter, 316SS



Also available:

Step up and step down adapters
in all sizes and in these materials:

304 Stainless Steel

Polypropylene

Kynar®

Hastelloy

Exotic Metals

Electropolished Finish



DID YOU KNOW?

Rubber Fab fittings and adapters are also available in
304 Stainless Steel.

CONSULT FACTORY FOR DETAILS.

Sanitary Clamps

Single Pin Sanitary Hinge Clamp



Size Inch	Part Number	A Dimension Inch	Max psi @70°F
1/2 & 3/4	13MHHM-304-050/075	1.13	1500
34MM	13MHHM-304-34MM	1.50	750
1 & 1-1/2	13MHHM-304-100/150	2.13	500
2	13MHHM-304-200	2.66	450
2-1/2	13MHHM-304-250	3.19	400
3	13MHHM-304-300	3.72	350
4	13MHHM-304-400	4.83	300
5	13MHHM-304-500	5.63	200
6	13MHHM-304-600	6.69	150
8	13MHHM-304-800	8.69	100
10	13MHHM-304-1000	10.70	75
12	13MHHM-304-1200	12.70	50

Single Pin Gold Clamp For Inline Identification

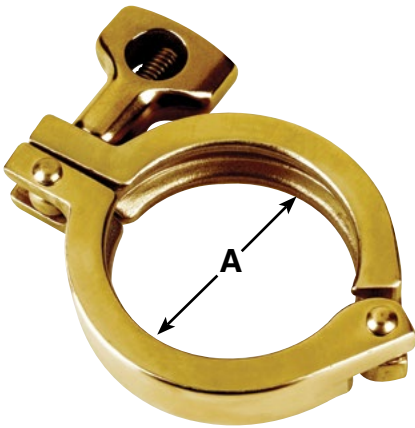

Size Inch	Part Number	A Dimension Inch	Max psi @70°F
1/2 & 3/4	13MHHM-304-050/075-GLD	1.13	1500
1 & 1-1/2	13MHHM-304-100/150-GLD	2.12	500
2	13MHHM-304-200-GLD	2.65	450
2-1/2	13MHHM-304-250-GLD	3.19	400
3	13MHHM-304-300-GLD	3.72	350
4	13MHHM-304-400-GLD	4.82	300
5	13MHHM-304-500-GLD	5.63	200
6	13MHHM-304-600-GLD	6.70	150
8	13MHHM-304-800-GLD	8.70	100
10	13MHHM-304-1000-GLD	10.70	75
12	13MHHM-304-1200-GLD	12.70	50

Double Pin Sanitary Hinge Clamp

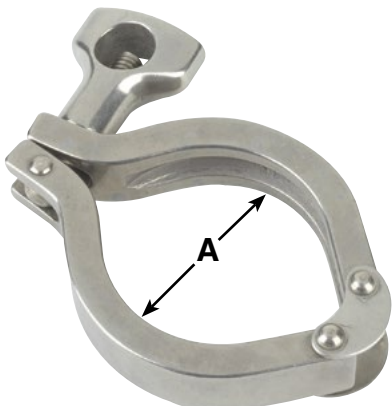

Size Inch	Part Number	A Dimension Inch	Max psi @70°F
1/2 & 3/4	13MHHM-DP-075	1.13	1500
1 & 1-1/2	13MHHM-DP-150	2.12	500
2	13MHHM-DP-200	2.65	450
2-1/2	13MHHM-DP-250	3.19	400
3	13MHHM-DP-300	3.72	350
4	13MHHM-DP-400	4.82	300
6	13MHHM-DP-600	6.70	150
8	13MHHM-DP-800	8.70	100
10	13MHHM-DP-1000	10.70	75

High Pressure Clamp

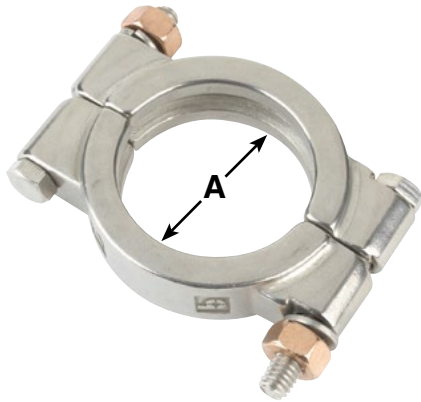

Size Inch	Part Number	A Dimension Inch	Max psi @70°F
1/2 & 3/4	13MHP-304-075	1.13	2200
1 & 1-1/2	13MHP-304-150	2.05	600
2	13MHP-304-200	2.58	550
2-1/2	13MHP-304-250	3.11	450
3	13MHP-304-300	3.64	350
4	13MHP-304-400	4.74	300
5	13MHP-304-500	5.83	400
6	13MHP-304-600	6.63	-

Three Segment Clamp

Three Segment Clamps are also available, consult factory for sizing and availability.

Non-Metallic Clamp



Size Inch	Part Number	A Dim. Inch	B Dim. Inch	R Dim. Inch	Max psi
1/2 & 3/4	13MHHM-NGW-050/075	2.17	0.75	0.39	150
1 & 1-1/2	13MHHM-NGW-150	3.94	0.75	0.89	150
2	13MHHM-NGW-200	4.64	0.75	1.26	150
2-1/2	13MHHM-NGW-250	5.20	0.75	1.50	150
3	13MHHM-NGW-300	5.75	0.75	1.77	150
4	13MHHM-NGW-400	6.66	0.75	2.25	150
6	13MHHM-NGW-600	8.81	0.96	3.14	150
8	13MHHM-NGW-800	11.14	0.96	4.32	150

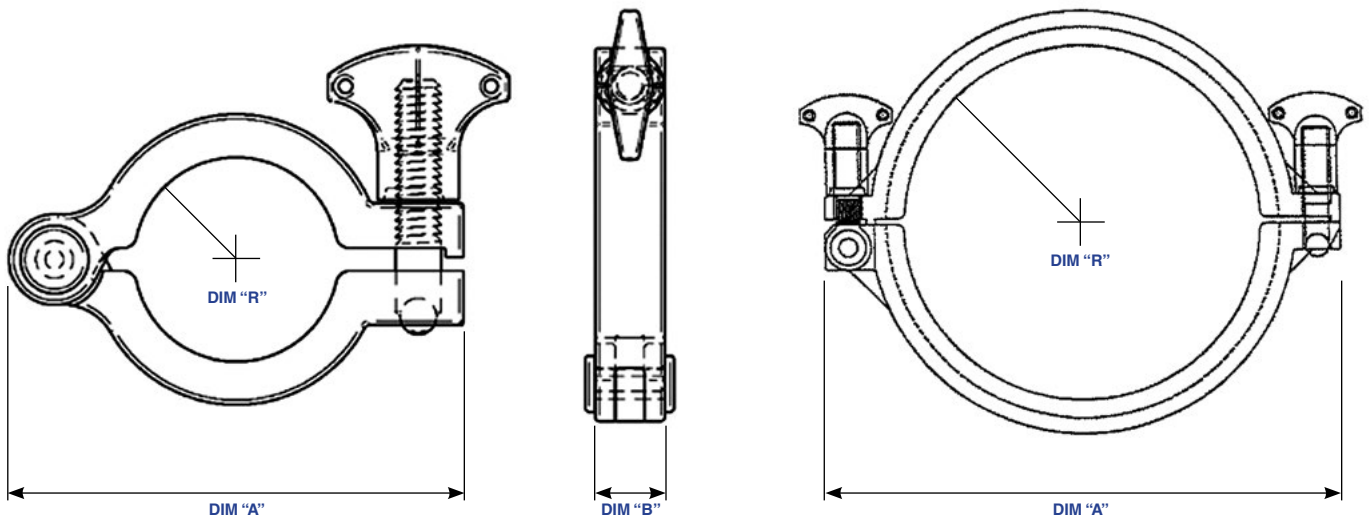

Torque Tee

Rubber Fab's Torque Tee and universal torque socket are designed to aid in clamp installation and removal. Available with a family of components, the Torque Tee handle creates effective tightening leverage and aids in reaching tight spaces, including over head and behind tanks.

Features

- Works with standard hinge clamp wing nuts
- Works with Rubber Fab's Torque-Rite®
- T-shape creates effective leverage
- Fast easy one handed tightening in the right direction
- Provides an audible click when any factory preset torque is reached
- Flanged reversing collar disengages the ratchet mechanism and locks the tool for conventional backing off and loosening
- All mechanisms are sealed in die cast handle
- Consult factory for other torques



Picture Reference	Product	Part Number
1	Tee Handle 30 IN LBS	TR-30-TEE-CP
2	Tee Handle 50 IN LBS	TR-50-TEE-CP
3	Universal Socket	WN/TR SOCKET
4	3 PC Extension Kit	TR-EXT-.25-SET
5	1/4" Swivel Joint	TR-SWIVEL-.25
6	1/4" Palm Wrench	TR-PW-.25
7	Torque-Rite® 30 IN LBS	TR-30
Not Shown	Torque-Rite® 50 IN LBS	TR-50

Torque-Rite®

Torque-Rite® allows you to control compression and expansion while maintaining constant inch/pounds force insuring a perfect surface ID. Torque-Rite® eliminates the problems associated with over or under tightening a seal which can lead to an unsanitary system. Compression control is easy! When tightened, the Torque-Rite's® self-limiting internal mechanism will make an audible "click" signaling the user they have reached proper inch/pounds force. The Torque-Rite® has a built-in manual override feature. If further tightening is attempted, there will be more "clicks" but no additional application of force on the sanitary gasket.

Features:

- An audible "click" indicating correct inch/pounds force
- Maintains constant 30 or 50 inch/pounds force
- Manual override feature
- Retrofits all sanitary clamps, mini-6"
- Works in rupture disk applications
- Works with Smart Gasket® thermocouple clamps
- User friendly
- Consult factory for additional custom torque nuts

Torque-Rite® is a registered trademark of Rubber Fab
Torque-Rite® United States Patent Number 6,082,941.

Part Number	Product
TR-30	Torque-Rite® 30 IN LBS
TR-50	Torque-Rite® 50 IN LBS

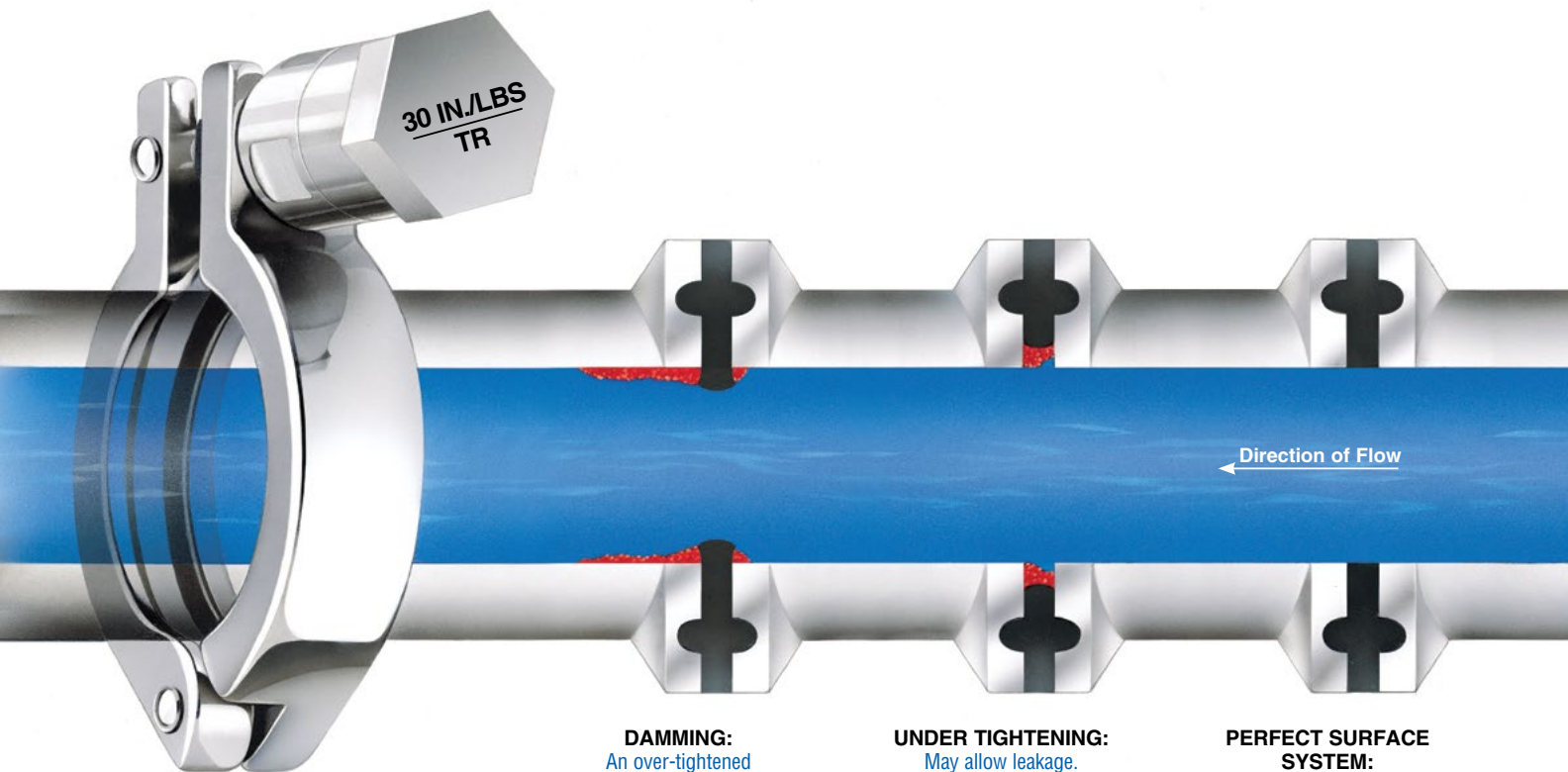

DAMMING:
An over-tightened gasket intrudes into the pipe, prevents draining, and allows deposits to build up behind the seal.

UNDER TIGHTENING:
May allow leakage. Can form concave surfaces at the product side of the gasket affecting free drainage and cleaning.

PERFECT SURFACE SYSTEM:
Torque-Rite® eliminates the concerns associated with over and under tightening a seal and insures that the gasket ID matches pipe ID

Smart Clamp™

The “Half-Turn” Sanitary Clamp

Rubber Fab is proud to introduce the next generation of sanitary hinge clamps — the one-piece, completely unitized, Smart Clamp™. With features that include half-turn installation and faster uptime, the benefits of Rubber Fab’s Smart Clamp™ far exceed any other sanitary clamp.

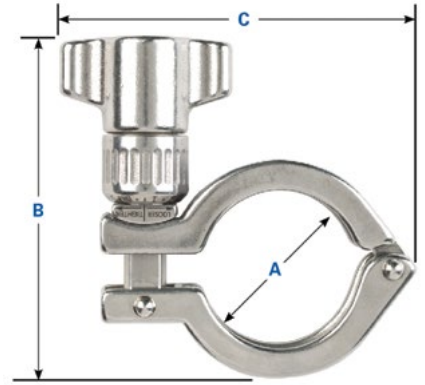

Size Inch	Part Number	Dimension in Inches			Service Pressure Rating	
		“A”	“B”	“C”	@ 70°F psi	@ 250°F psi
1/2 & 3/4	SMARTCLAMP-050/075	CF	CF	CF	1500	1200
34MM	SMARTCLAMP-34MM	1.50	3.88	3.50	500	250
1 & 1-1/2	SMARTCLAMP-100/150	2.90	4.00	4.25	500	250
2	SMARTCLAMP-200	2.72	4.50	4.75	450	250
2.5	SMARTCLAMP-250	3.25	4.75	5.50	500	200
3	SMARTCLAMP-300	3.76	5.00	5.75	350	150
3 Sch 5	SMARTCLAMP-300-V	4.32	5.38	6.25	350	150
4	SMARTCLAMP-400	4.89	5.50	6.87	200	125
6	SMARTCLAMP-600	6.77	6.50	9.00	100	50

CF = Consult Factory

Deeper clamp channel nests ferrules and gasket in place ensuring gasket alignment.

Easy adjust dial with multiple torque settings makes adjusting the Smart Clamp quick and simple.

Visual indicator lets you know Smart Clamp is fully engaged and installed when the arrow on the clamp and the arrow on the handle are pointing to each other!

The Smart Clamp beveled lip-lock holds clamp in place if setting needs to be adjusted and in case of accidental hit.

User-friendly handle and half-turn installation helps prevent repetitive strain injury conditions.

Value Added Services

Electropolishing



Electrochemical in nature, electropolishing uses a combination of rectified current and a blended chemical electrolyte bath to remove flaws from the surface of a metal part.

Electropolish is available for Rubber Fab's stainless steel fittings and adapters.

Passivation

Passivation involves a shielding outer-layer of corrosion which can be applied as a micro-coating. As a technique, passivation is the use of a light coat of protective material such as metal oxide to create a shell against corrosion.

Pressure Testing

Rubber Fab has the capability to pressure test hose and assemblies for you if needed. This service is available upon request.

Private Labeling



Rubber Fab will print your logo and contact information on Rubber Fab's product labels providing a reorder point for your customer.

Custom Fabrication

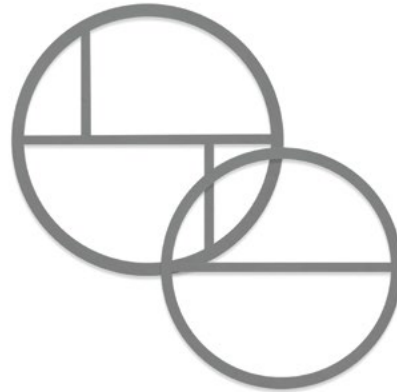

- Custom machined fittings and gaskets
- Spool pieces
- Waterjet custom parts
- Tanks/Vessels

Rubber Fab is your complete resource for custom fittings and sanitary gaskets. We will review your part drawing or sample fitting and give you a prompt quotation. Rubber Fab creates custom parts from Tuf-Steel's® heat resistant sheet and rod. Please contact Rubber Fab's Technical Sales team for all of your application needs.

360° Radial Crimp



Rubber Fab's hose fabrication team offers 360° radial crimping to our sanitary hose for a positive lock that enables the assembly to be used to the maximum working pressure of the particular hose style and size without fitting pull-off or blowing off.

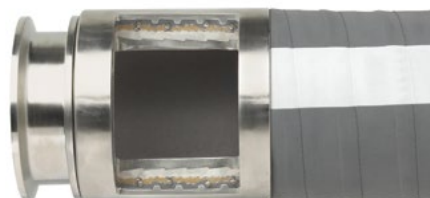

Laser Engraved Barcoding



Use etched collars to communicate your most critical information. Part numbers, sizes, service dates, and usage recommendations are just a few examples. Laser etched collars present a sharp, legible, professional image. Include your company name, application specific information such as serial numbers or maintenance codes, and more.

Barcoded Packaging Labels



Barcodes are used to track anything from products to people to even military equipment. Use barcoded labeling to communicate your most critical information. Part numbers, sizes, packaging information and usage recommendations are just a few examples. Printed barcode labels present a sharp, legible, professional image.

Laser Etched Hose Crimping Collars



- Sharper and more legible than traditional acid-etched parts or handwritten labels.
- Print logos, barcoding, and QR coding.
- Use product serialization (incremental counting) for tracking purposes.
- Use etched collars to communicate your most critical information. Part numbers, sizes, service dates, and usage recommendations are just a few examples.

Laser-Etched Tags



- Easy to attach to hoses
- Inexpensive way to identify
- Etch critical date, i.e., hose maintenance and replacement dates, part numbers, logos, pressure and temperature ratings, contents, suction or discharge service

Quality Assurance Documentation

Material Test Reports (MTRs) for complete lot and batch traceability for stainless steel parts fittings and adapters.

Rubber Fab ships products with a certificate of conformance.

It is Rubber Fab's quality policy to provide the highest quality products, which consistently meet the product specifications developed by Rubber Fab and their customers, both internal and external. We are committed to the continuous improvement of our quality system. We will meet and exceed the expectations of our customers.

Rubber Fab Gaskets Meet the Most Stringent Standards For Purity:

- U.S. Pharmacopeia Class VI Certification*
- Cytotoxicity Criteria*
- Title 21CFR177.2600 and 177.1550
- USDA and 3-A Sanitary Standards
- Current Good Manufacturing Practices (CGMP)
- ASME-BPE Standards
- ISO9001:2000 and QS-9000:1998
- Animal Derived Ingredient Free*

*Buna does not pass U.S. Pharmacopeia Class VI Certification And Cytotoxicity and is not ADI Free®.

Limited Warranty

Rubber Fab warrants their products to be free of material and workmanship defects for a period of 3 months from the time of delivery. Any product deemed to be defective in that time period by Rubber Fab's quality assurance department will be replaced or repaired or at Rubber Fab's discretion refund the purchase price. This is the limit of our liability. Defective products must be returned with an authorized material return authorization number. The product(s) must be returned prepaid freight. Freight charges will be refunded if credit is allowed against the warranty.

Rubber Fab does not make or imply any other warranty and does not accept consequential damages.

Rubber Fab does not warrant the suitability of materials for specific applications.

For the latest in products, specifications, and dimensions,
please visit www.rubberfab.com

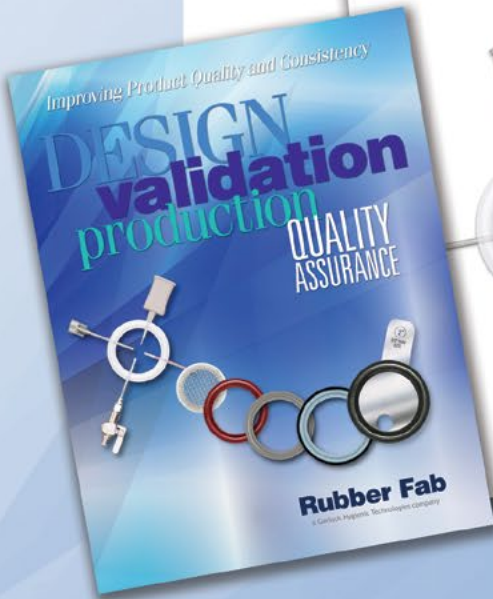
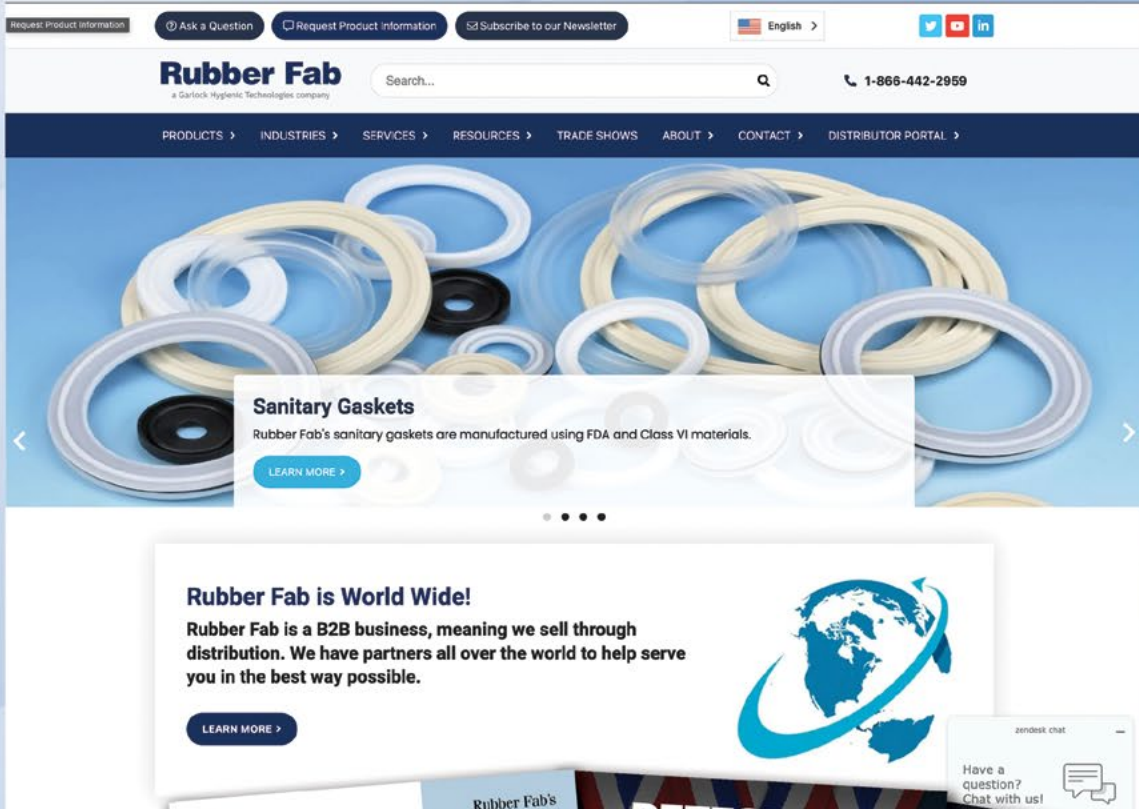

Rubber Fab

a Garlock Hygienic Technologies company

26 Brookfield Drive • Sparta, NJ 07871
Phone: 973-579-2959 • Fax: 973-579-7275
Tollfree: 866-442-2959

www.rubberfab.com

Rubber Fab is a member of:

ISPE



fisa
Distributors Serving
Sanitary Processing



Distributed by: